

Rebel Walls®

• CLAIM YOUR SPACE •



BEST OF

CHAPTERS



BOTANICAL | PAGE 4-21



SURFACES | PAGE 22-39



NATURE | PAGE 40-57



KIDS | PAGE 58-75



MAPS | PAGE 76-93

Between the hard covers of this book you'll find 40 extraordinary and unique designs divided into 5 inspiring categories.

These are the most beloved, bold and beautiful designs from our wallpaper journey so far. High-end modern design classics that will definitely help you define and claim your space.

Claim Your Space

Everybody needs a place to claim as their own. A quiet hideaway where you set the rules.
These places go under many names: hobby room, library, garage, walk-in closet...
No matter what you call them – claim them.

Rebel Walls provides the tools to solve a universal need by offering
an infinite assortment of wall murals and the knowledge of how to choose.

Be a rebel – Claim your space!



Add wealth and harmony to your home with a botanical mural. Green is the color that represents all things alive, from the smallest leaf to large fields and deep forests.



BOTANICAL



R13051 **R**

Bellewood

This inviting and mysterious forest is based on several toile designs where we only picked the trees from the romantic sceneries. If you want to fill the woods with a love message of your own, you can always use our design studio to carve your beloved's name in one of the tree trunks.



R13052 **R**



R13053 **R**



R13054 **R**

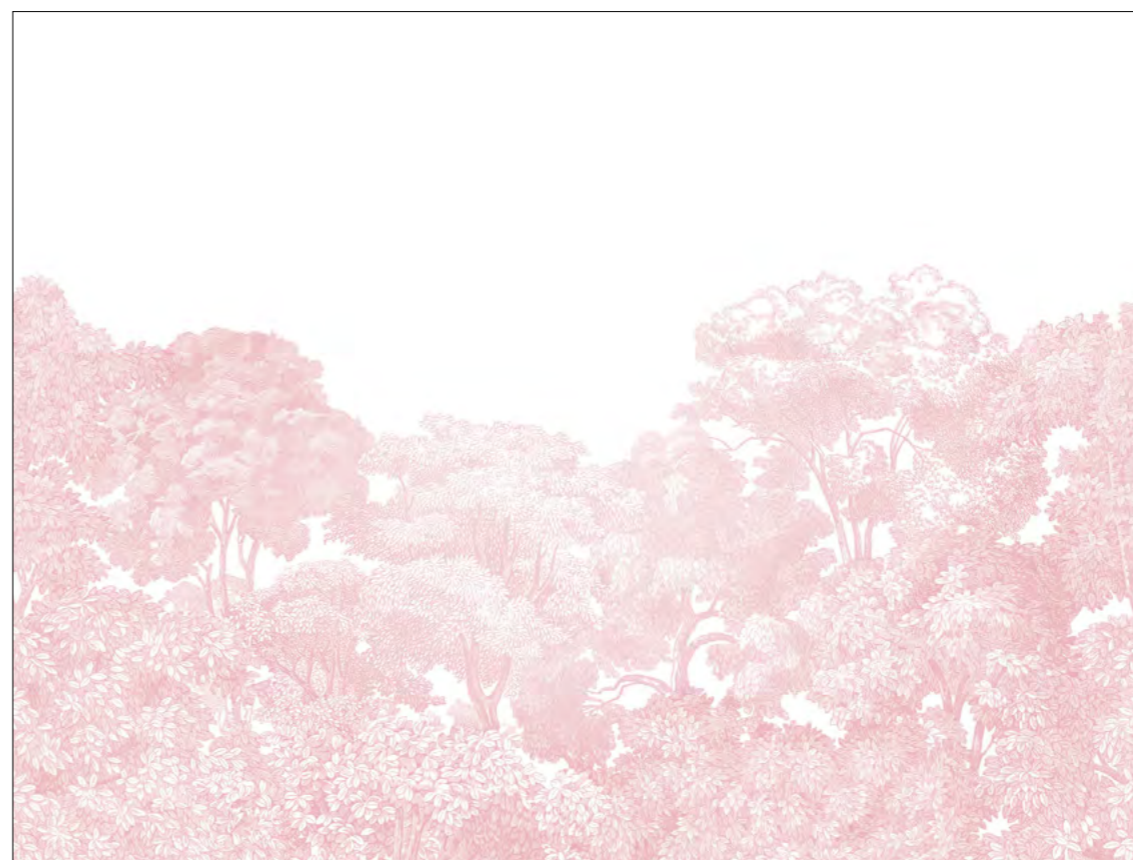

R13057 **R**



Perspective Jardin

The windows offer a glimpse at progress seeking to overtake the past. Looking out, you can see that man has lost the battle with nature here. This mural will give you depth, view, and perspective to a room without a garden view.



R14371 



BOTANICAL 9

REBEL WALLS | BEST OF

Mischievous Monkeys

You'll find the curious monkey and his brisk friends hiding amongst the lush green foliage of this wallpaper. The jungle you create looks straightforward at first glance, whether it's on one wall or throughout a room – only revealing the hidden cheeky monkeys on closer inspection.



R14591 

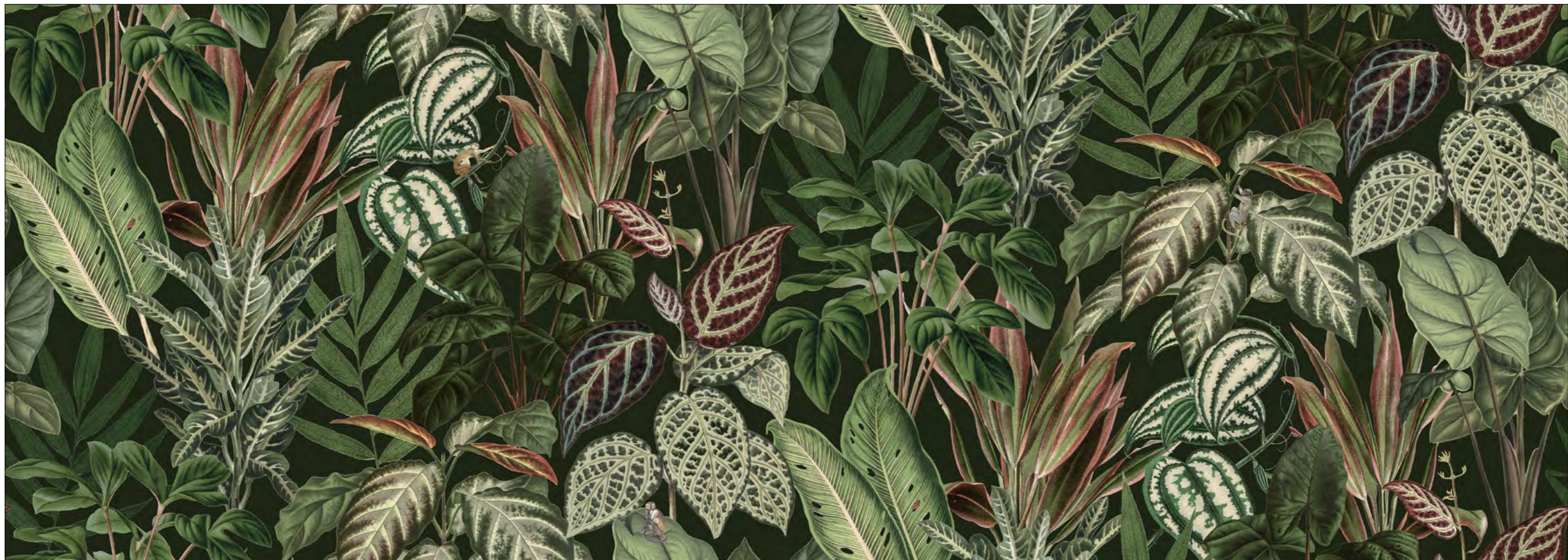

R14592 







R14531 

May Meadow

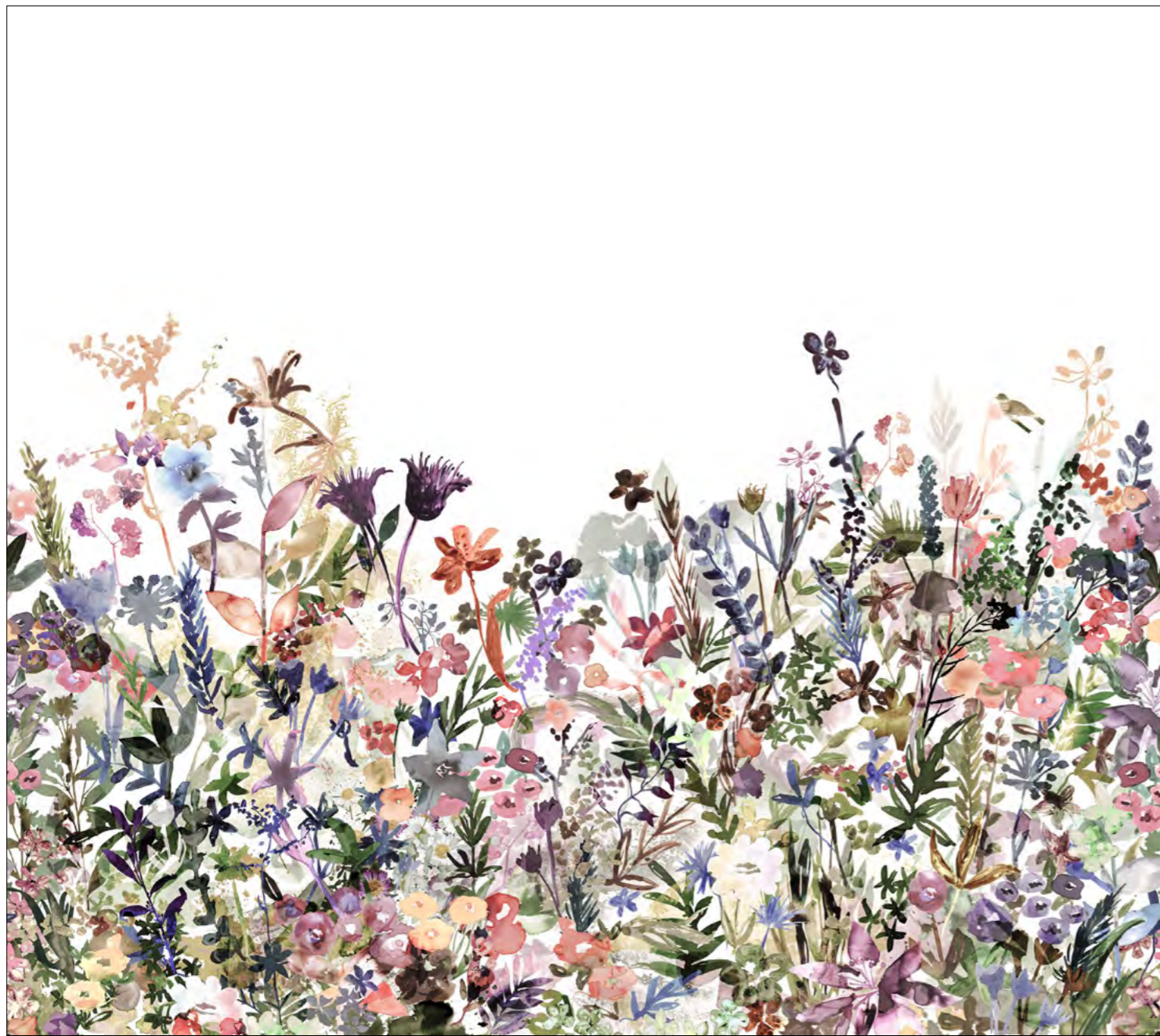
This wild meadow is inspired by stories of journeys – long and dangerous – and by the dream of finding a place to call home at their end. The mix of flowers in this pattern creates a riot of color, and this wallpaper can be used throughout a room to produce a springtime meadow of your very own.



R14532 





R13141 

Meadow

Is it difficult to decide which is your favorite of all wildflowers? Then take the entire meadow home with you!



R13142 





BOTANICAL 15

REBEL WALLS | BEST OF

Blooming

The breathtaking beauty of flowers in full bloom is delightfully perceived in this classic oil painting. Giving the illusion of an old oil painting, the colors have dried out creating charming cracks that run decadently over the canvas. This statement wall mural is grandiose and irresistible at the same time.





R15391 

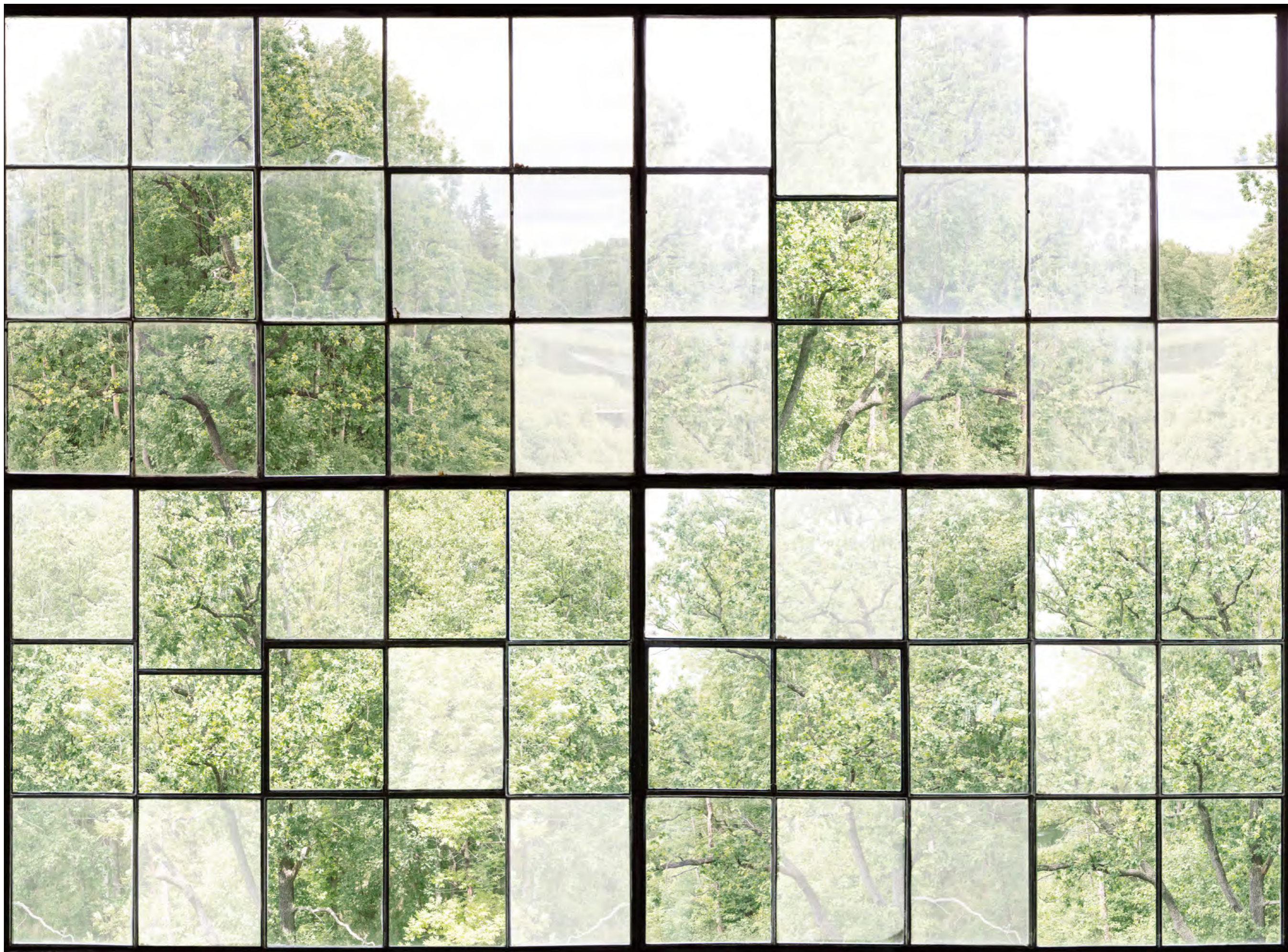

Factory Window

These are windows from an old textile factory – some of them are old, from the factory's glory days, and some are new, installed to keep out the rain. This wall mural will give you depth, view and light to a room without a garden view.



R14381 



Leaf Love

Green is said to be the color that the human eye can determine the most shades out of, that is – the richest color! Create a lush green corner of your home with this courageous mural. A diagonal grid runs across the motif for a softer expression.



R14001





Transform the look of your walls and the decor of your room with a stunning surface mural. Whether you like the look of concrete, traditional bricks or steel plates, we got it!

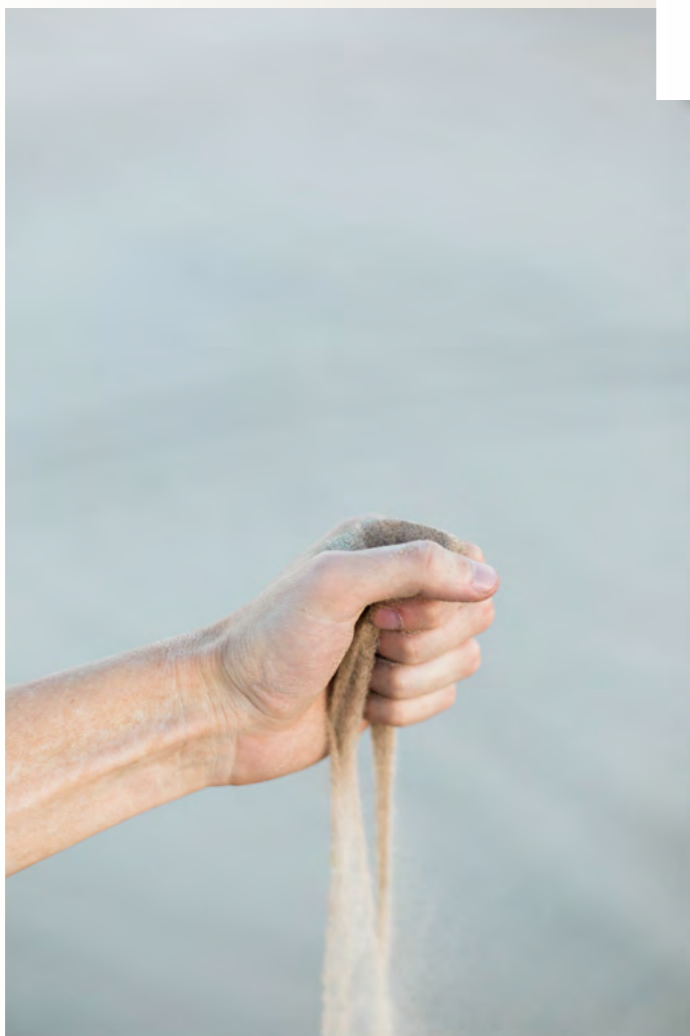

SURFACES



Patina

This is a hand-painted wallpaper design giving every room a patinated vintage feeling.



R12711 



Industrial Ivory

Whilst ivory paint has often been the choice of muted, traditional spaces; this wall reveals the aesthetic grace that can be found in the aging process. It's a contemporary twist on a more traditional paint choice.



R14321 



Perspective Manoir

This may be the last image caught of this magnificent inner façade – the walls and floor almost caved in when shooting this photo. The true-to-size windows offer light and a view where there was previously just a plain wall.



R14201 



Wooden Concrete

This concrete surface brings a raw, yet subtle look to your wall.



R15001 



Steel

This wallpaper design is picturing scratched, metal clad, steel plates creating a cool industrial image for your home. Its cool facade enhances the contrast between soft and hard, warm and cold. Combined with big soft blankets and pillows it will feel like home. Or keep the cool industrial style if you dare to be edgy.



R12671 **R**



ALUMINUM
TRADE MARK
MADE IN U.S.A.

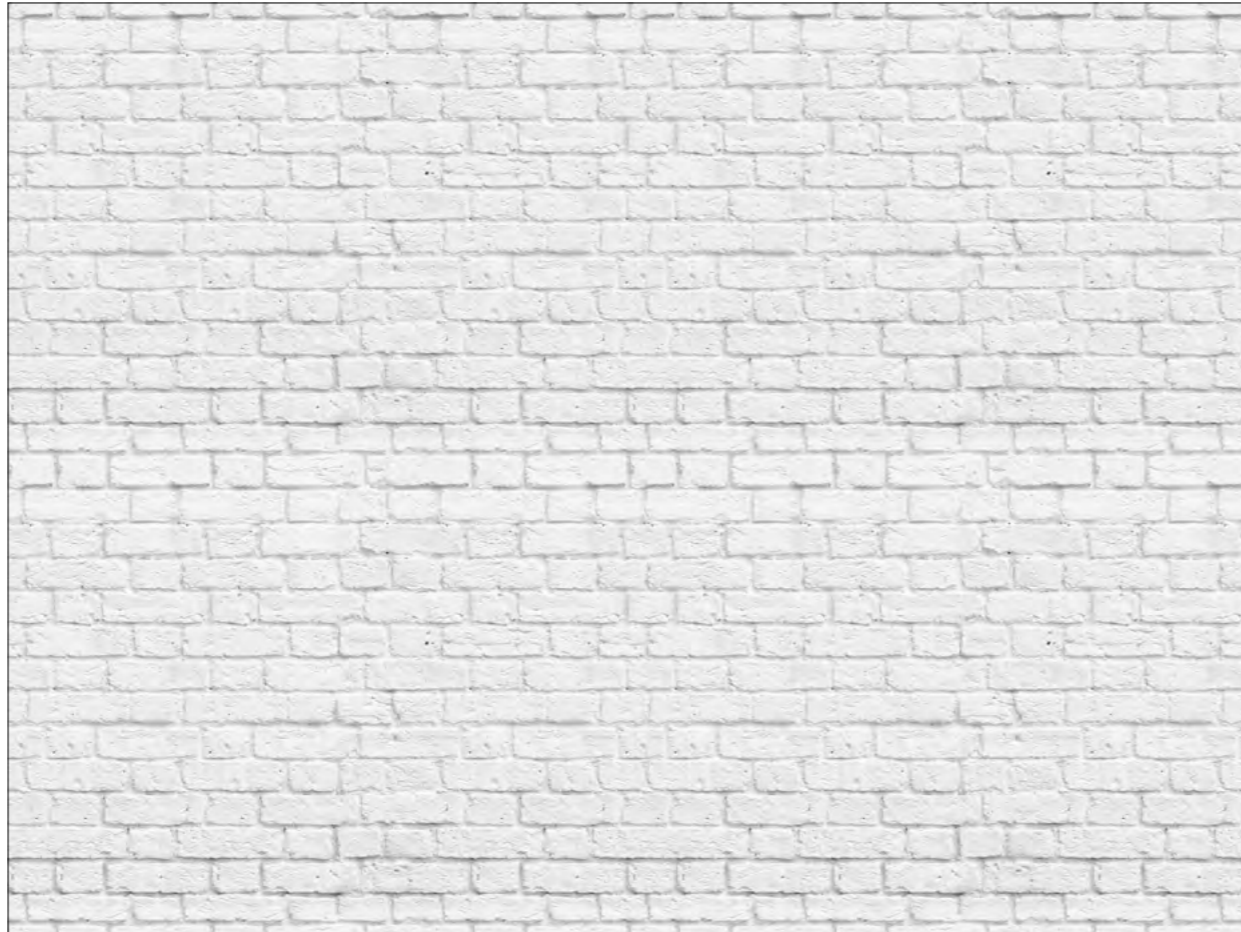

R14871 

Soft Bricks

Ever wanted a brick wall? These white bricks fit perfectly in any space you would like to wallpaper.



R14873 

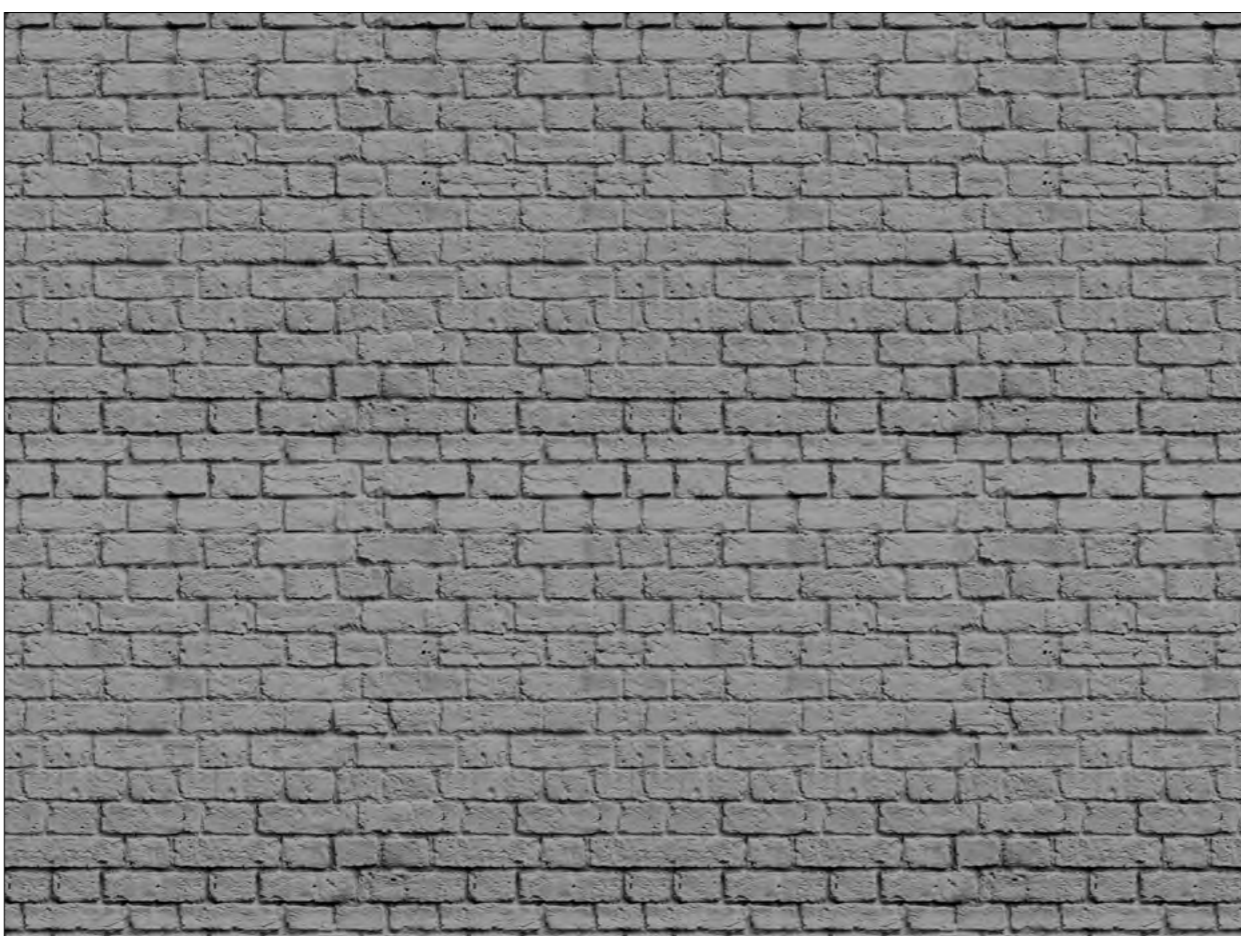

R14872 



Battered Wall

This wall exists at our favorite café. When they renovated and stripped the wall off it's layers of wallpaper and paint this beautiful surface emerged. The wall looked so good they kept it the way it is. Since it has become a great source of inspiration to us it was only fitting that we should share it. We booked a photo shoot and the wallpaper Battered Wall came to be. It looks just as nice at the café as it does in a home. Where would you hang it?



R12791 



Industriel Urban Farm L.A.

The crates are real boxes collected from all over California. If you happen to be in L.A. and are hungry for urban French cuisine, you simply must visit the lovely restaurant sharing the name with our wall-paper design Industriel Urban Farm L.A.



R12901 **R**



R12902 **R**



M&H
BOTTLING CO.
NEW YORK

SANDEAN
DETROIT

WELCH

CANADA DRY BOTTLING CO.
BRAND RAPIDS MICH.

100 51
143
50
IMPORTED BY
JAMES M. MCCURN CO. INC. FOR
ESTRADA IMPORT & EXPORT CO.
2109 STRAND
GALVESTON, TEXAS.
PERMIT NO 10-187.

LOS ANGELES
7up
SEVEN UP BOTTLING CO.

H.P. HOOD & SONS
BOSTON, MASS.
CHARGE CASE

LOS ANGELES, CALIF.
Eurelys

EXCELSIOR BOTTLING CO.
READING PA.

BEVERAGES
READING PA.

THE RED STRIP STAMPS REQUIRED BY
SECTION 2803 OF THE REVENUE CODE TO THE
CONTAINERS OF DISTILLED SPIRITS IN THIS CASE
CONSISTING OF 24 BOTTLES BEARING
STAMPS OF 1/4 PINT DENOMINATION
JOHN BEGG LTD.
24 AMERICAN GALLONS

BERWYN
5° DAIRY 40

SANFORD'S
ROYAL CROWN
MUGILAGE
SANFORD MFG CO.
CHICAGO AND NEW YORK

BERWYN
5° DAIRY 40

GRAND ISLAND, NEB.

M&H
BOTTLING CO.
SAN ANTONIO, TEXAS.

EXCELSIOR BOTTLING CO.
CARBONATED
BEVERAGES
READING PA.

Hires
1876
ROOT BEER
WITH ROOTS-BARKS-HERRIS

SOCIETY
SOCIETY

Nature has a calming effect on your way of living, and with the help of a wall mural, you get the opportunity to be close to nature even though you may live in a busy town.

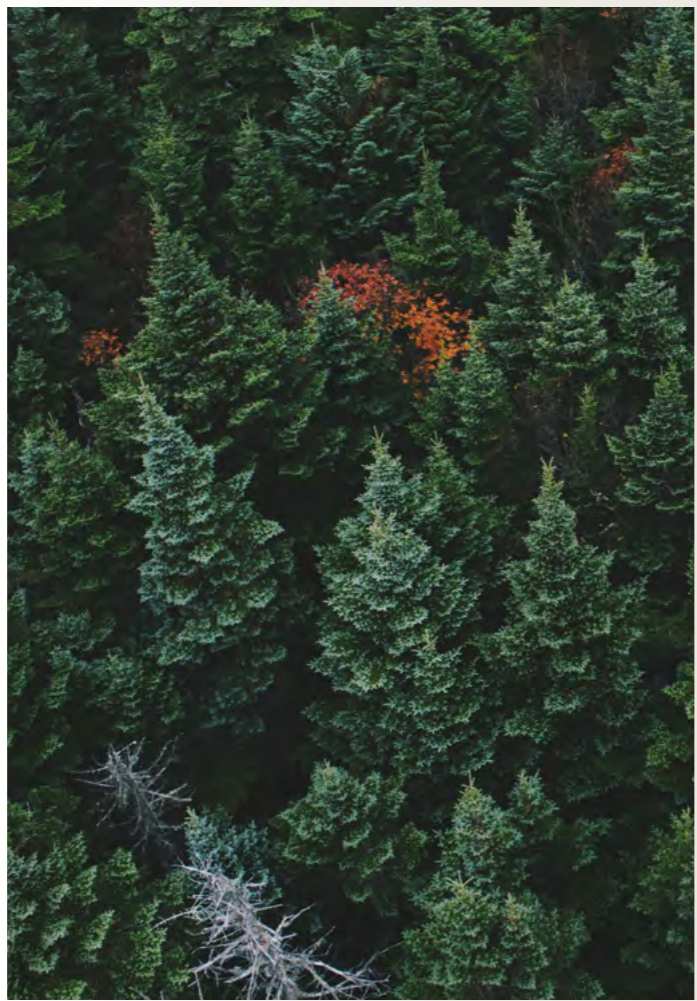
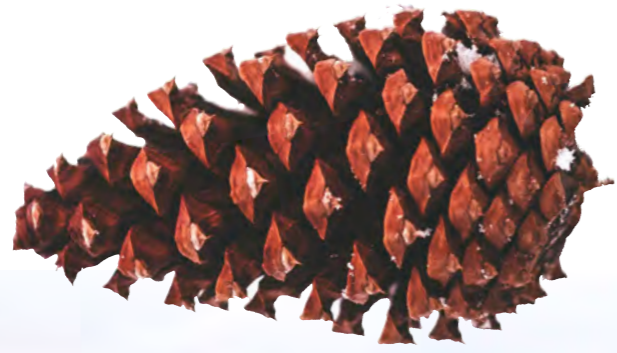

NATURE

Morning Fog

Fog among the trees creates a soft gradient grayscale – this subtle, yet stunning wall mural design will give your room a soothing atmosphere. The way the mist blends in with all the trees almost got an artistic approach, doesn't it?



R15301 



Cuddle Clouds

Who hasn't dreamed of taking a nap surrounded by fluffy clouds? In Cuddle Clouds, your dream can become a reality. Just place the tapestries in the bedroom and dreamlike rest will surely be achieved. The wallpaper is repeatable sideways.



R14011 



Swaying Reed

Experience summer in its full beauty – a calm breeze from the ocean quietly sways the reed. Dress the room with that sense of coast and sea at its best. This wallpaper is repeatable sideways and works just as well on one or several walls in the room.



R13602 



Birch Trunks

Bring the Scandinavian forest home with you. In winter, birch trees become minimalistic with their simple white trunks and dark branches.



R13031



Pine Forest

The pine trees in this picture stand in the foreground and in the background, this creates a certain depth to the image and you almost want to step in to the wilderness and see where the path is taking you. There is something mysterious about the view, real but surreal at the same time.



R13711



Above The Clouds

Who hasn't dreamed of flying? With this wallpaper your thoughts get visual support, providing you the same view that you would have if you had wings. Fluffy blue and white clouds surround you.



R13681

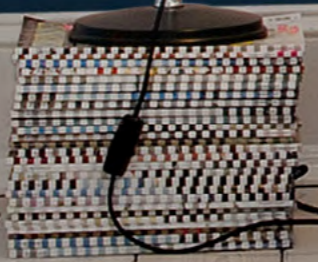

Scandinavian Light

A sea of grass in Gotland surges across this wallpaper in shades of blue, inspiring calm and clarity.



R12971



NATURE 55

REBEL WALLS | BEST OF

Old Pine Trees

A peaceful photo wallpaper depicting courageous pine trees overlooking the ocean.



R13021



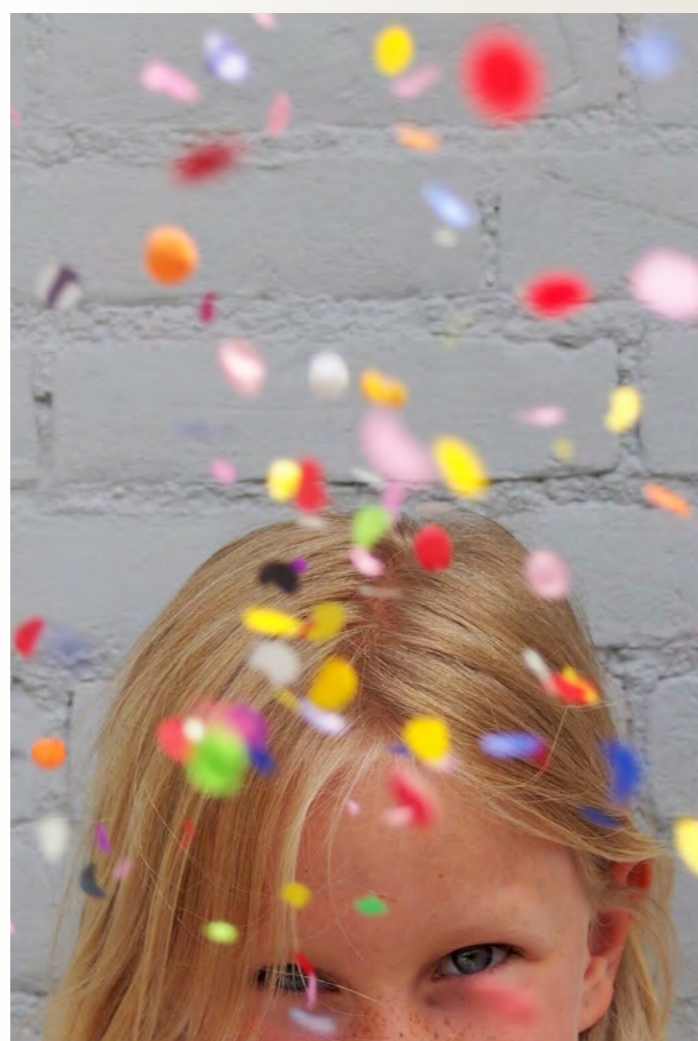

Dream big! Whether your little one wants to visit the jungle, ride on a wave or look up at the starry sky – nothing is impossible.



KIDS



Woods of Wonder

These giant mushrooms will have you feeling like you're in a land of wonder, whether you're a little or a big kid. The sideways repeatable design plays with perspective and has the potential to dwarf an entire room.



R14481 





R14461 

The Enchanted Forest

This design brings to mind secrets and shadows, and is inspired by an enchanted forest where magical creatures tread softly upon the fern beds. This sideways repeatable design can be used throughout a room to create a really powerful effect.



R14462 





The Rabbit's Playground

This detailed woodland scene is home to many good friends, playing comfortably and planning their next great adventure. The sideways repeatable design can be used for more than one wall, to create a woodland oasis wherever you choose.



R14551 



High Seas

Adventure and daring are what treasure hunts are made of, and this sideways repeatable design captures that feeling perfectly. It's inspired by the old-fashioned copperplate illustration technique, full of hand-drawn lines and a real sense of the time taken to produce such a work.

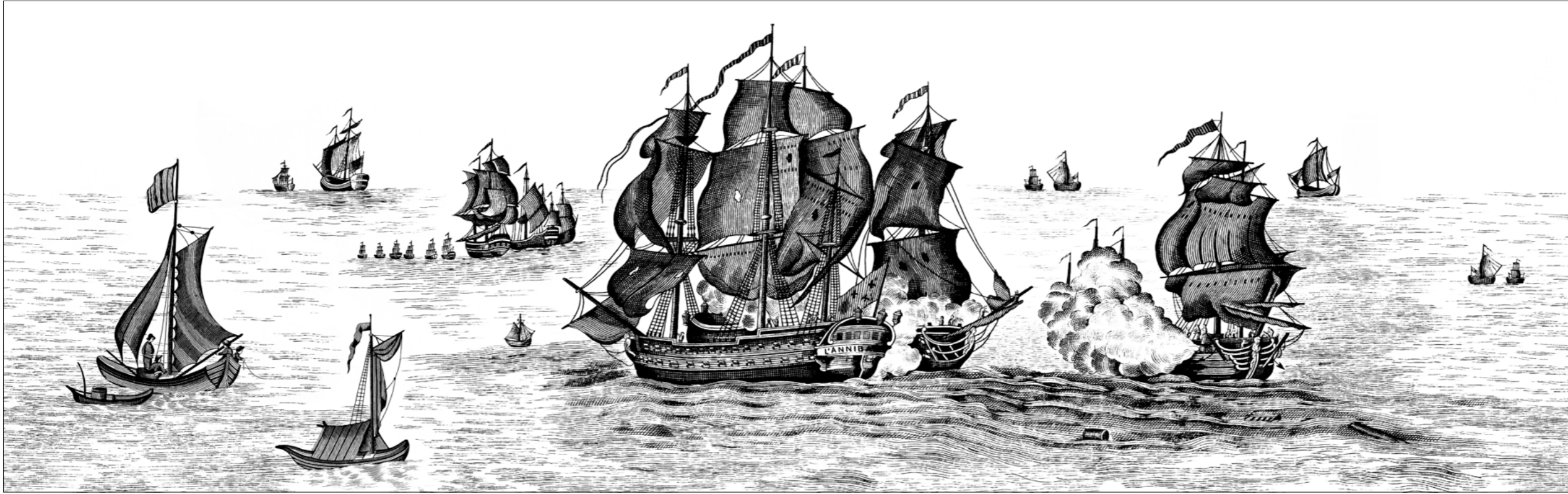

R14501 **R**



R14502 **R**

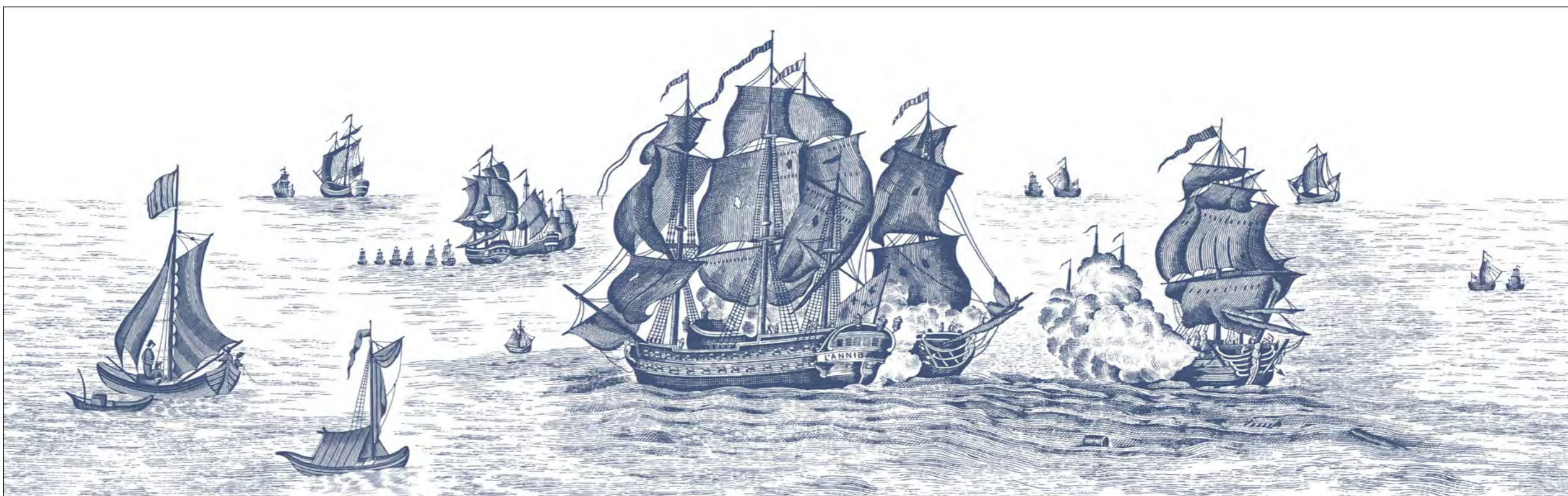

R14503 **R**



UP ALL NIGHT



R14611 **R**

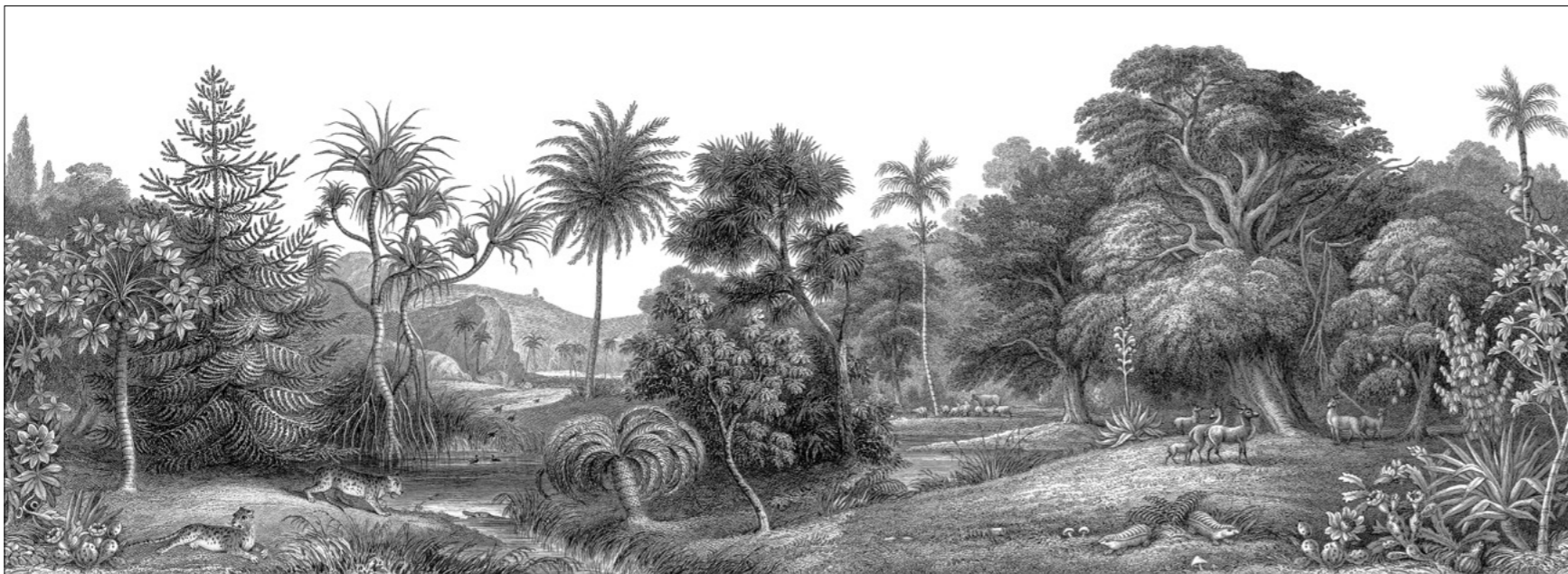

R14612 **R**



R14613 **R**

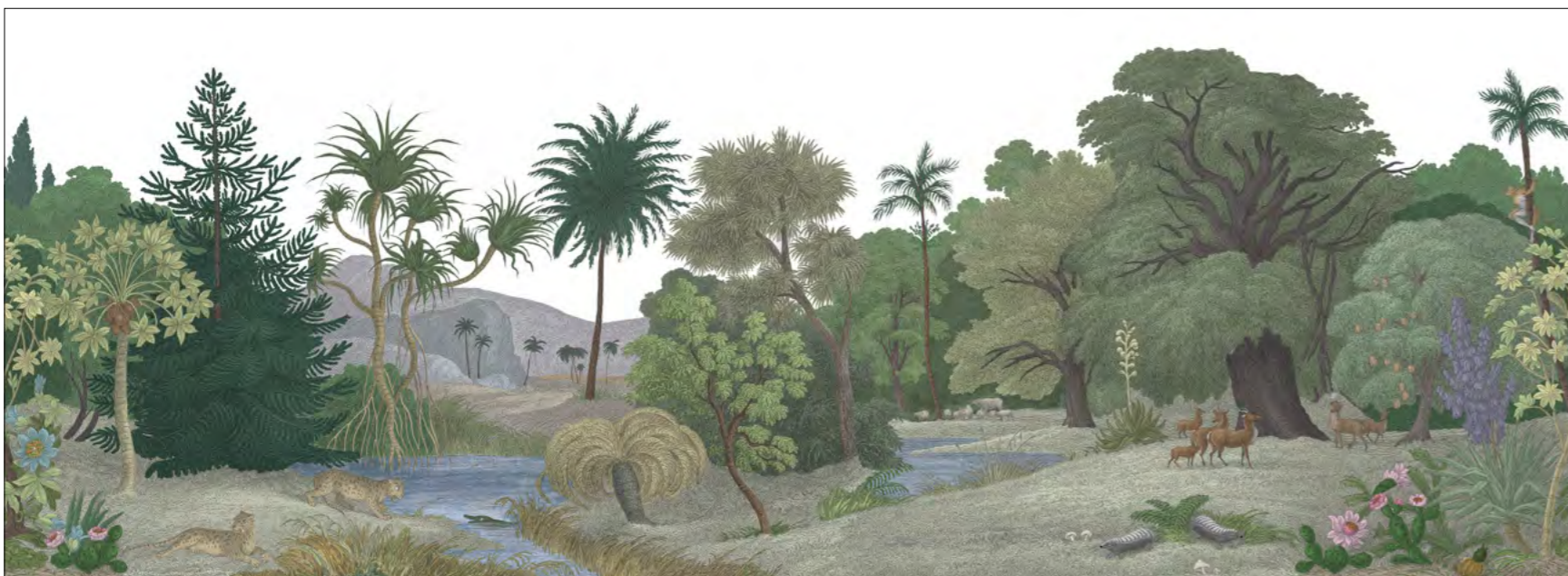

R14614 **R**

Jungle Land

An exotic jungle in a faraway land – or at least as it was imagined by the unknown artist who once upon a time created the illustration that this wallpaper mural pattern was based upon. Evoke dreams in your own home about distant shores, and the creatures awaiting beneath the trees in the jungle, with this fascinating wall mural.





London Houses

In North West London, you'll find Notting Hill with its adorable townhouses. Here you see our take on their timeless architecture – created with 2D drawings, arranged and photographed in 3D.



R14601 



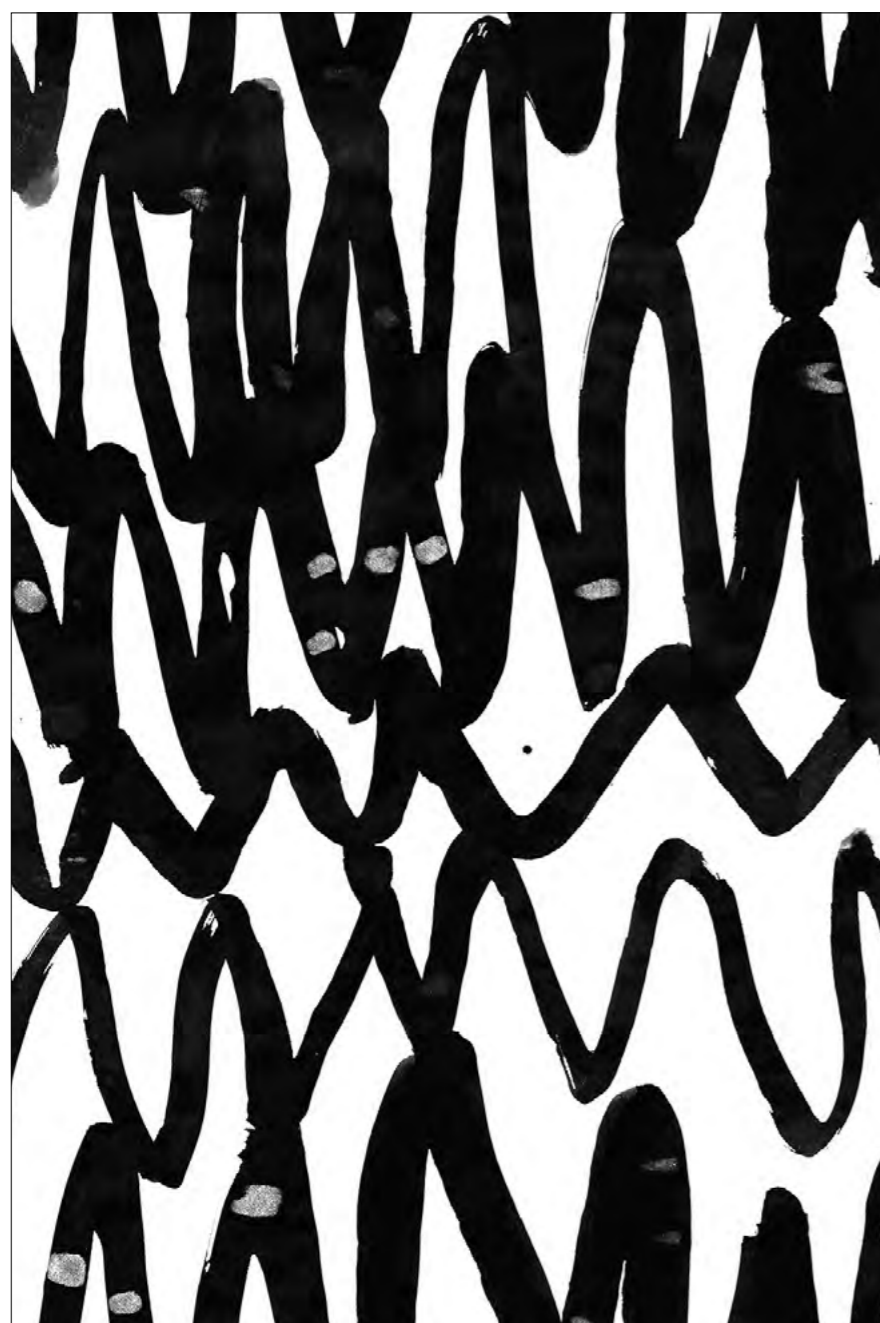

R14091 **R**

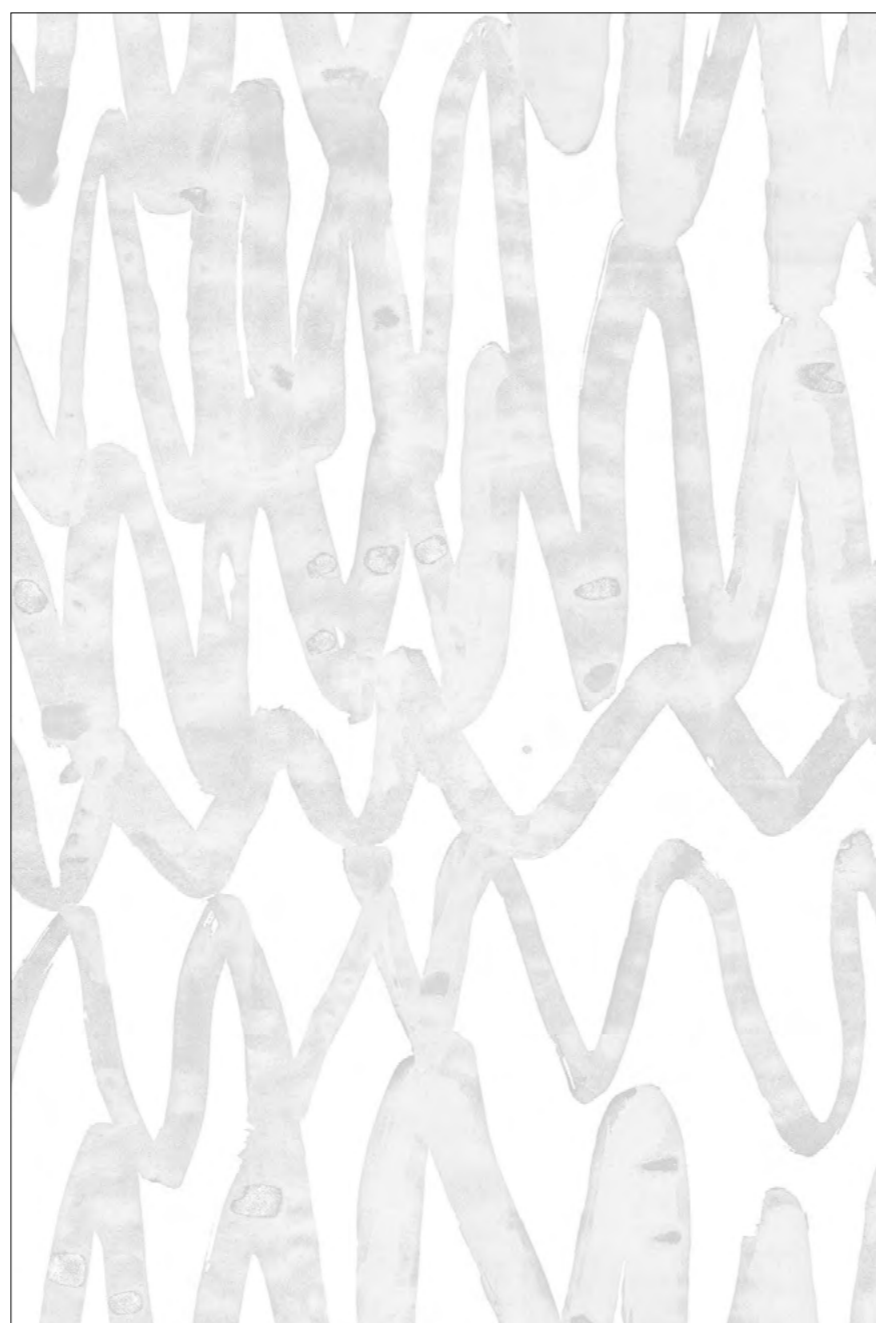

R14092 **R**

Pulse of Passion

Wide strokes of the brush without hesitation, sudden stops in the line, a caution which generates its own pattern and then new, sudden and delightful flings in the pattern. This is a crazy pattern, but we love it and its cheeky lines!



R14093 **R**



R14094 **R**



R14095 **R**



Verona

Love graffiti from the walls of Casa Di Giulietta – Juliet's house in Verona, Italy.
From William Shakespeare's famous play "Romeo and Juliet" 1595.



R13731 **R**

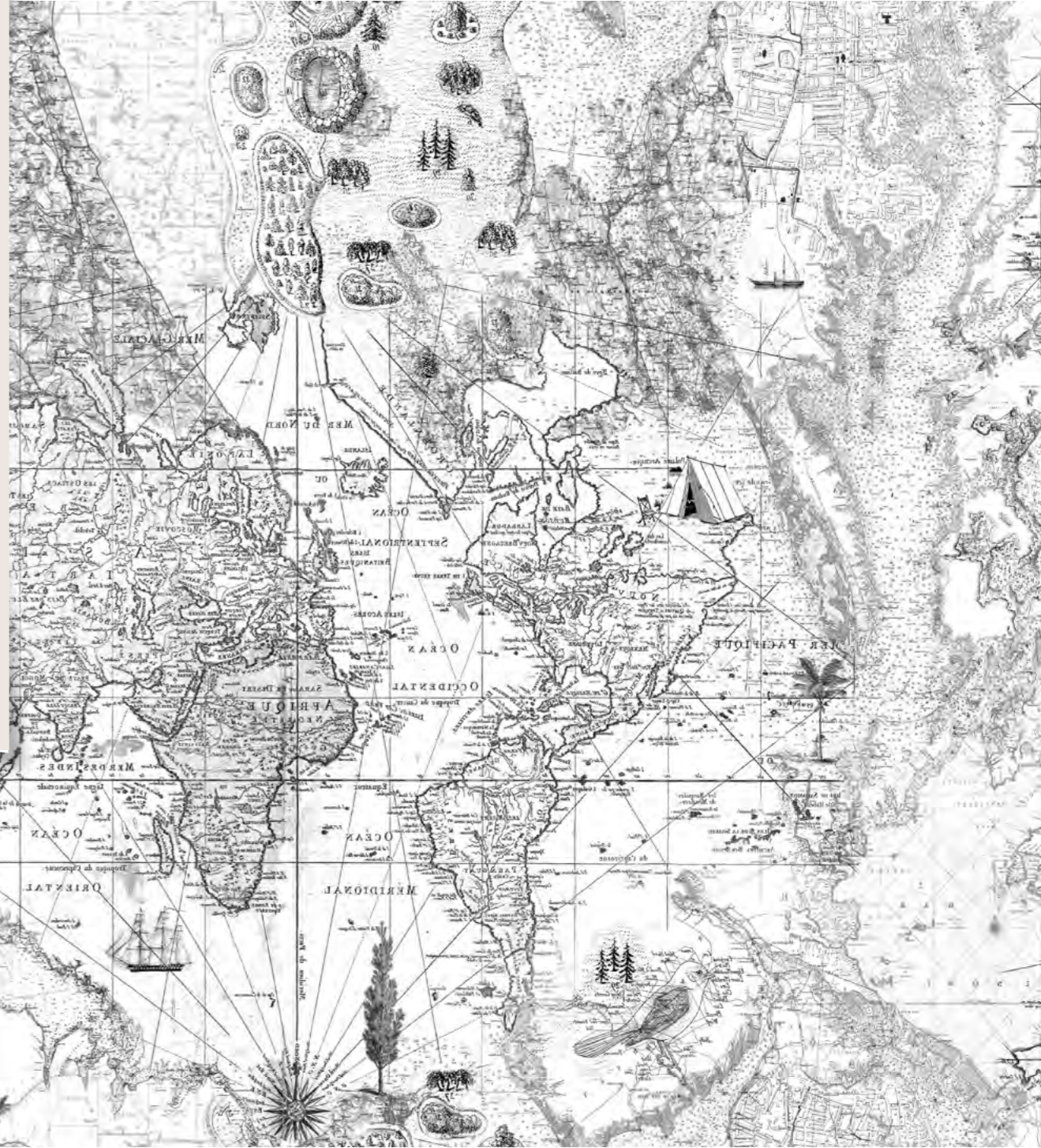

Maps haven't only been used for navigation, but also as a form of communication throughout world history. They have a unique way of introducing ideas and concepts – in an artistic way.

MAPS





School Atlas

Do you remember the school maps? The zealously accounting and heavily used ones? Here, we have one of those as a wall mural. Beautiful and well-used, and in some places the paper has even developed holes.

R13901



R13902



Globes Gathering

Get the multicultural mindset going with this complex, yet stylish pattern with terrestrial globes.

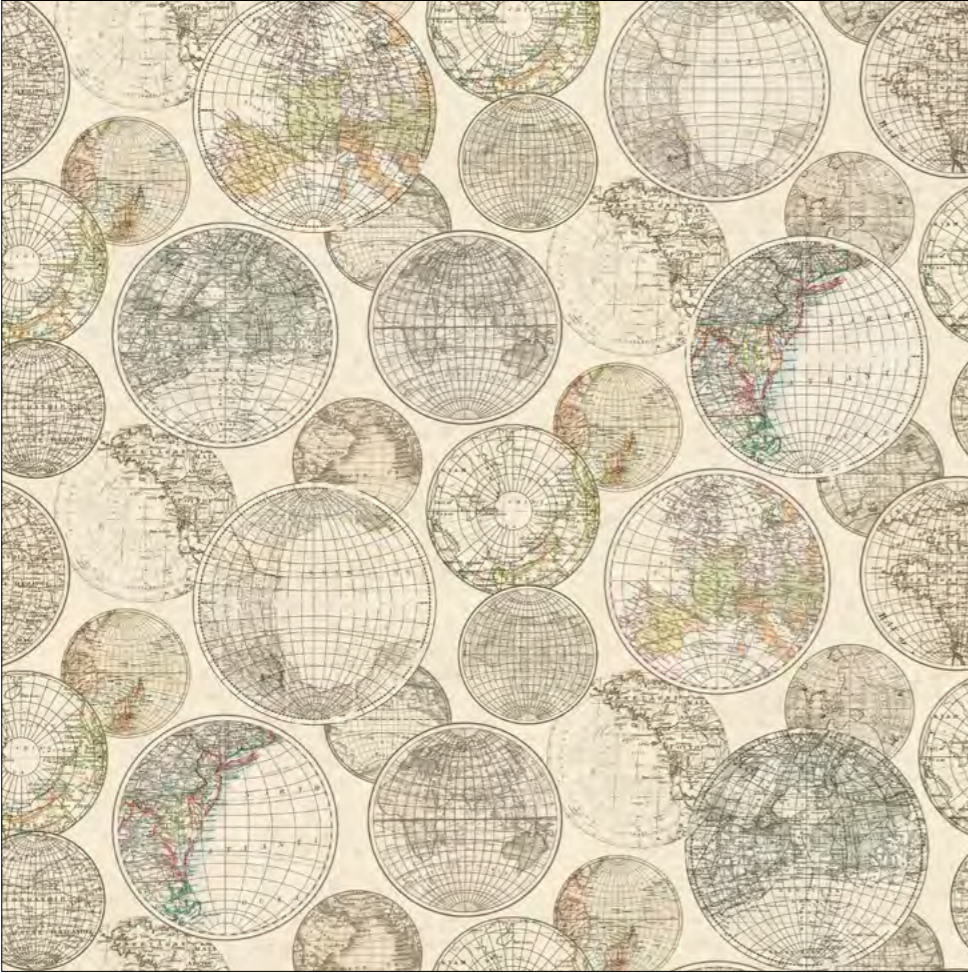

R13881 **R**

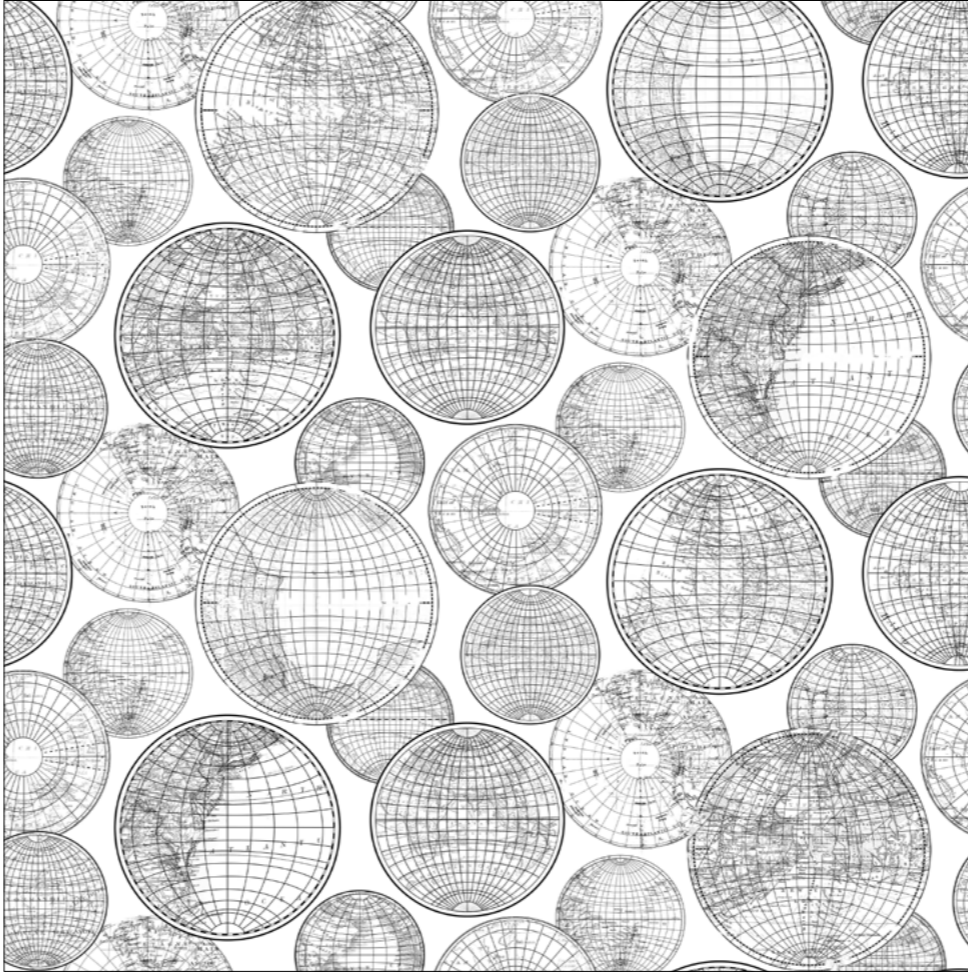

R13882 **R**

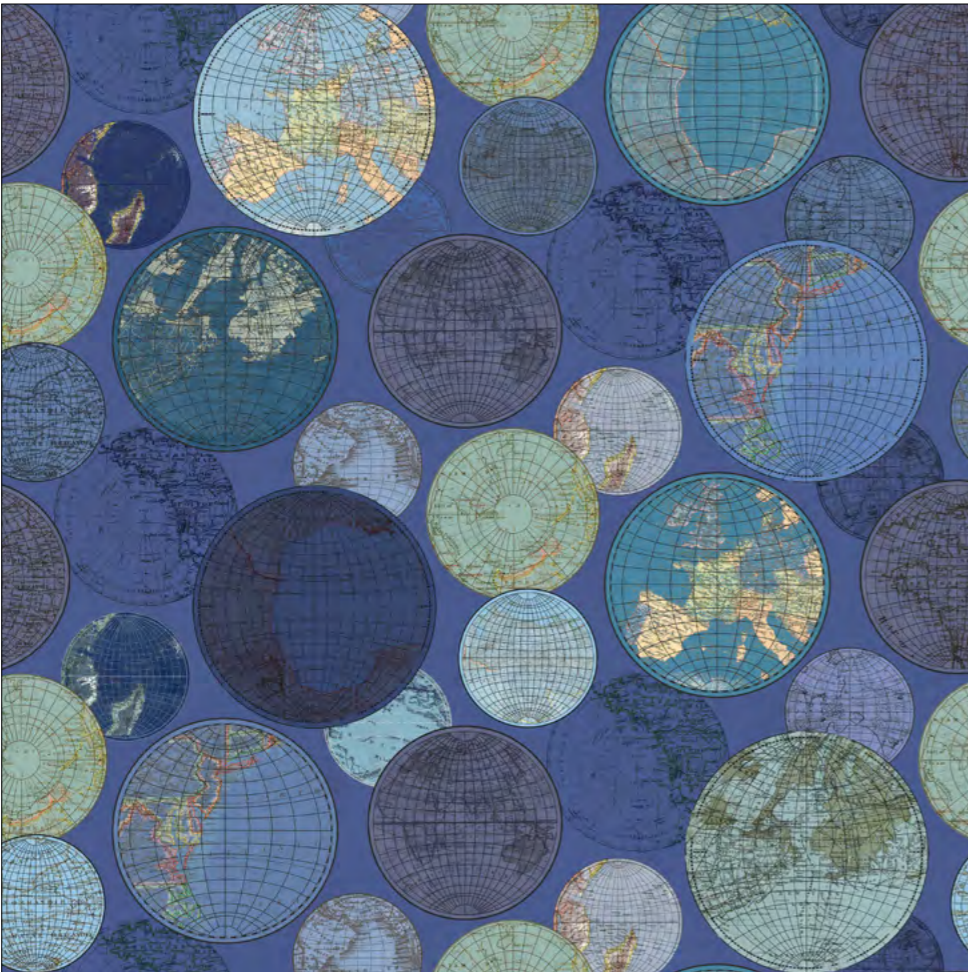

R13883 **R**



R13884 **R**



Paper Mountains

Sheer maps in layers upon layers meet illustrations and the soft grayness of the graphite pencil. Place the wallpaper on every wall of the room to create an entire mountain range, with the birds' flight over the mountains as the finishing touch.



R13871 



Around the World

Whether you're planning to conquer the world or just planning a trip, this world map wall mural will inspire you. Choose your own world view with this spinnable world map design – enter your wall dimensions and find your favorite spot in the world.



R15351 



ESTAS TU VIDA.
HAZ LA VIDA QUE AMAS.
Y HAZLO COMO QUIERAS.
SI ALGO TE ESTABA CAMBIANDO.
SI NO TE HUBIERA PLEDO, RENUNCIA.
SI NO TIENES TIEMPO DEJA DE VER TV.
SI ESTAS EN UN BUEN MOMENTO DE TU VIDA.
ESTARAS EN UN BUEN MOMENTO DE TU VIDA.
A HACER LAS COSAS QUE QUIERAS.
DEJA DE VER TV.
LA VIDA ES UN VIAJE.
ABRE TU MENTE.
PREGUNTA.
Y COMPARTI.
VIAJA.
ALGUNAS OPORTUNIDADES VIENEN UNICA.
LA VIDA SE CREA.
Y LO QUE SE CREA SE CREA.
ASI QUE SI QUIERES EMPEZAR.
LA VIDA ES VIVIR.
C

Atlas of Astronomy

A wallpaper for the ceiling. Straight up. What else? This is an amazing illustration of the northern hemisphere's star map anno 1869. Illustrated constellations rest against an unimaginably beautiful, blue-toned background. Would you dare?

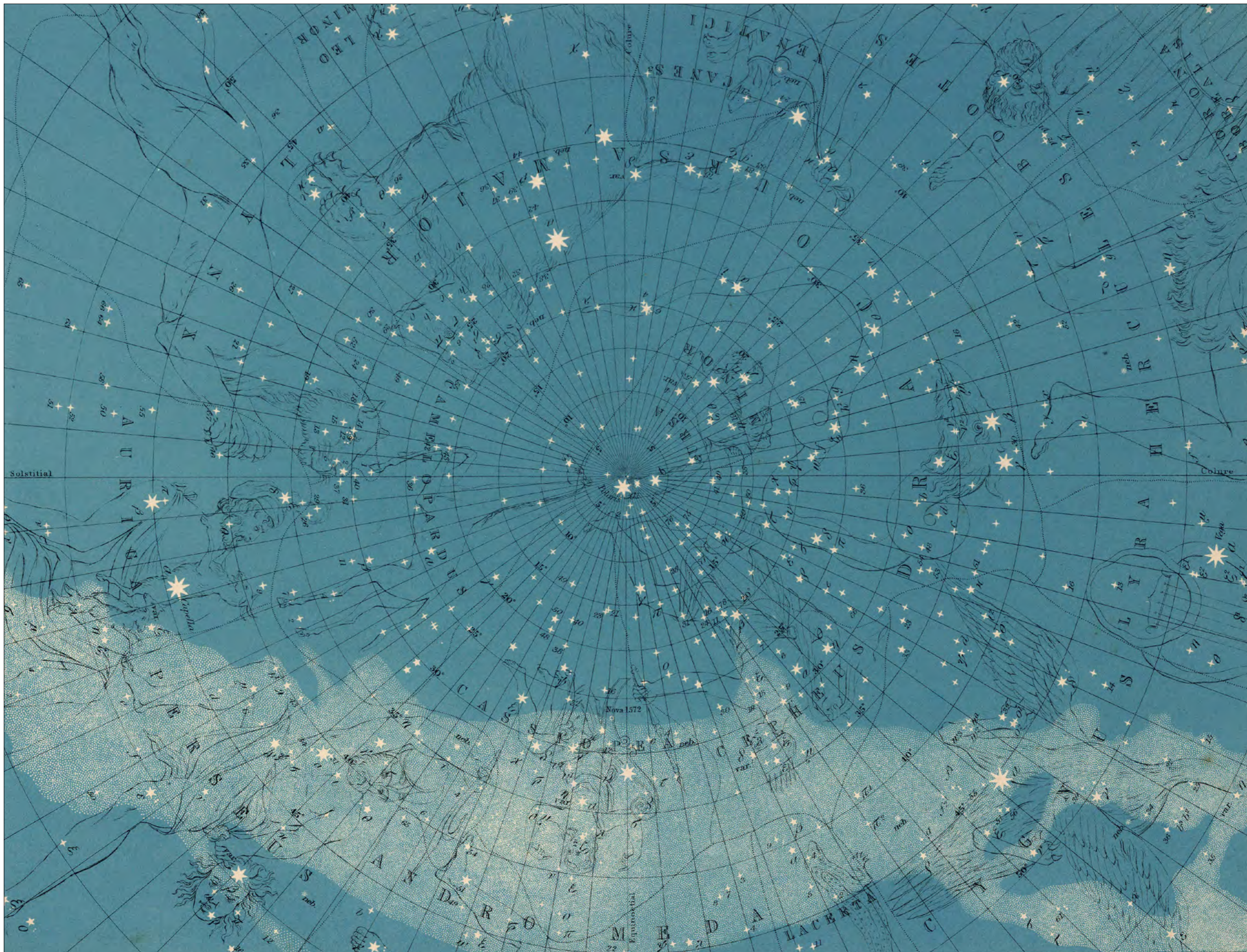

R13811





R10771



R10772



R10773

World Map

Whether your planning to conquer the world or just planning a trip, this world map wall mural will inspire you.







R13861 **R**



R13862 **R**



R13863 **R**

Treasure Hunt

Can you find the tent? The ship? The palm trees? In this wall mural with its ingenious pattern, you can go on endless expeditions. Compilations of different types of maps are the foundation for the design. Create a saga of your own while traversing the terrain.





R13431

Rainbow World

This lovely world map mural would not look out of place in most rooms in your home, but it would also grace an office or reception area. The attractively colored land masses in rainbow hues have a soft, subdued water color effect, making them visually appealing to the eye. The merging of the colors give movement to the picture.

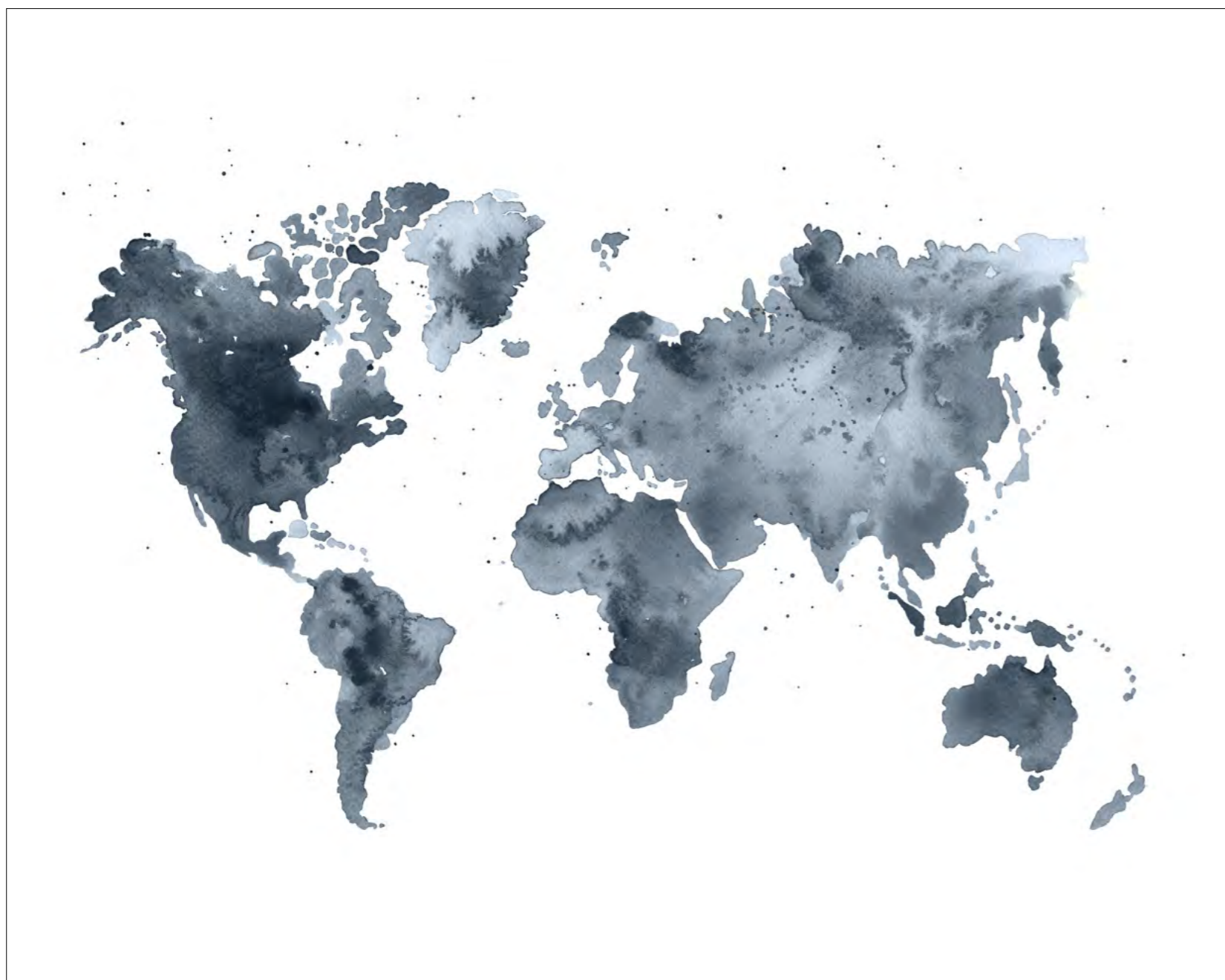

R13432





HANGING INSTRUCTIONS

Follow these hanging instructions and your wallpaper will be up in no time!

→|← = STRAIGHT MATCH

1

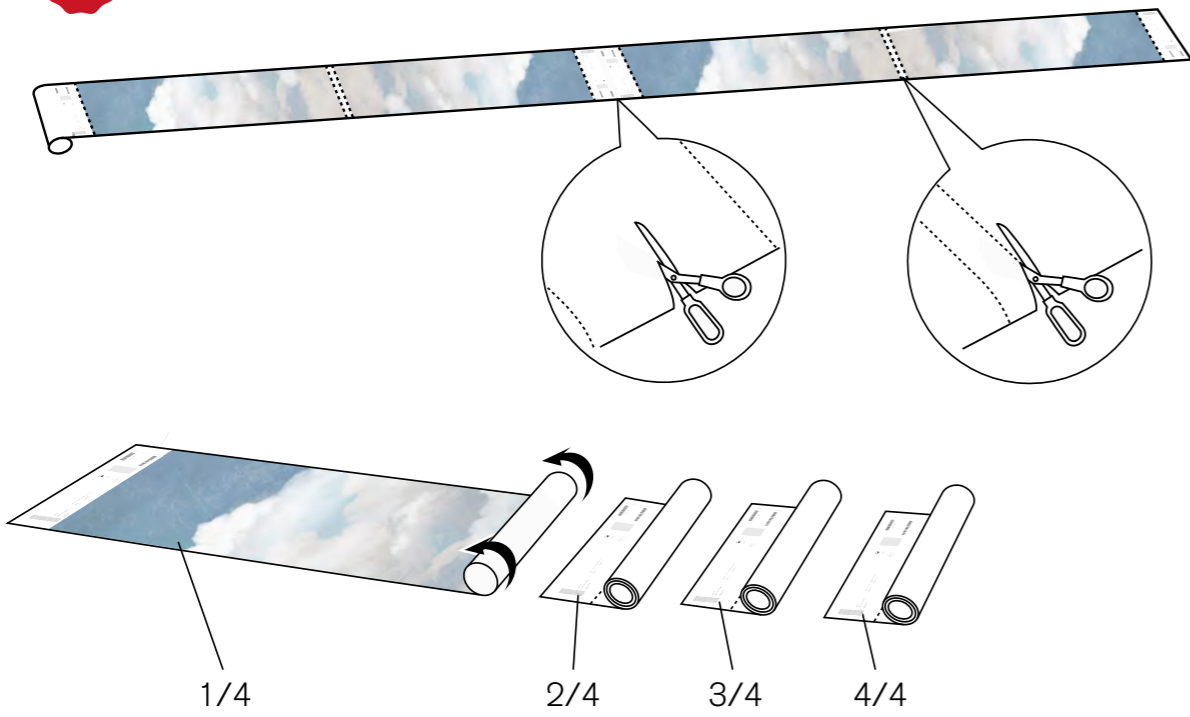

45 CM

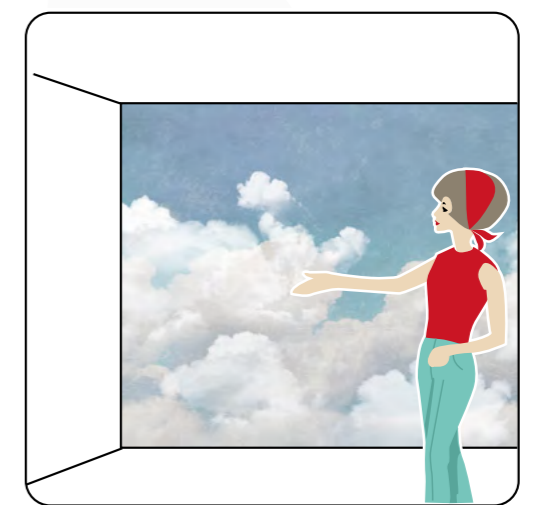
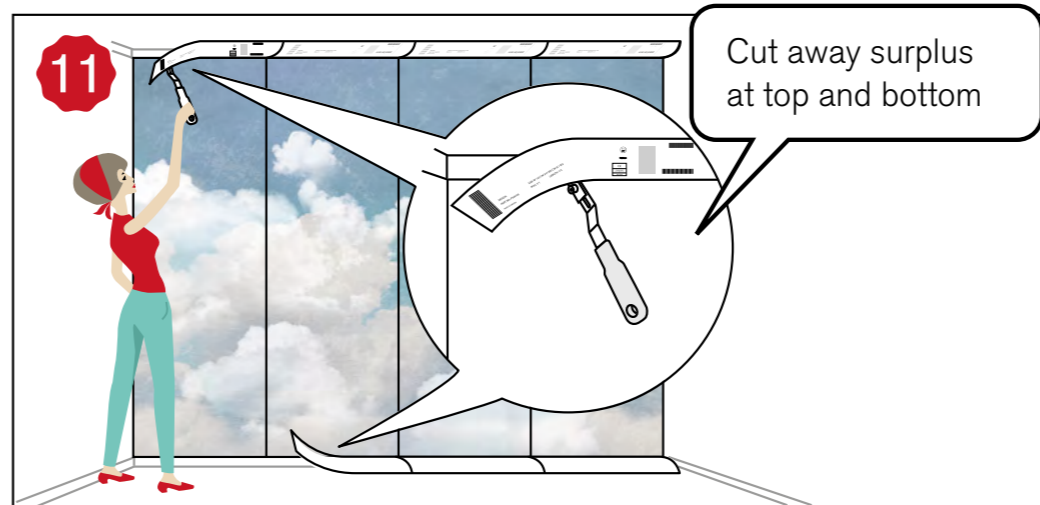
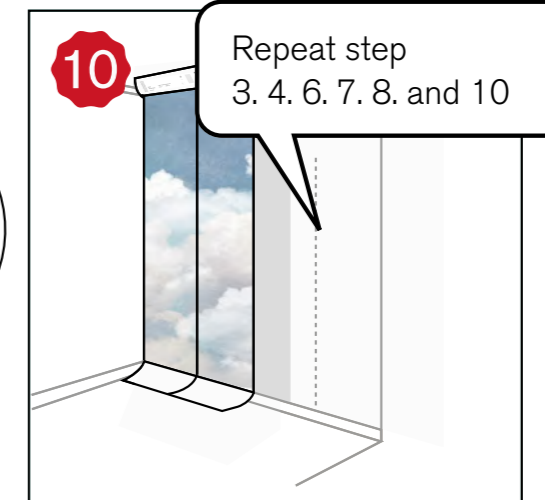
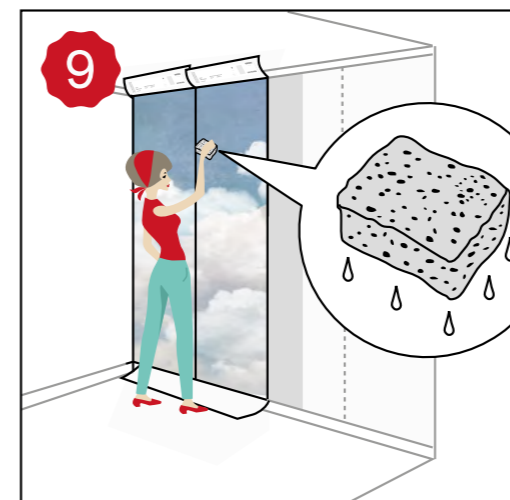
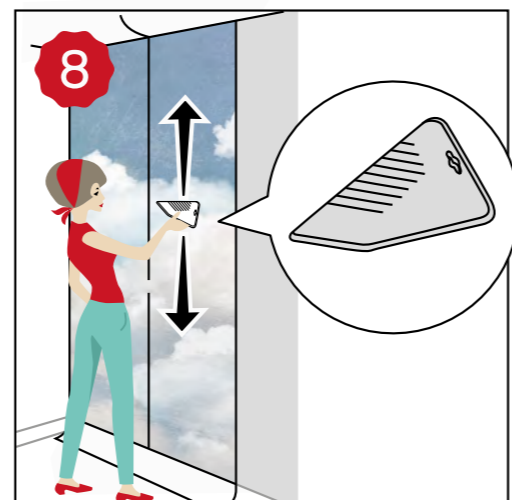
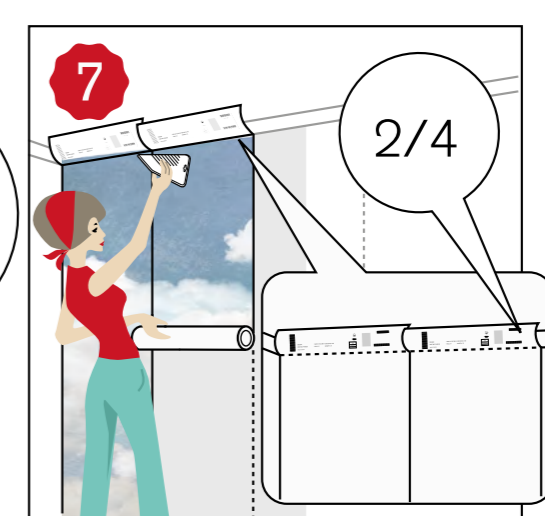
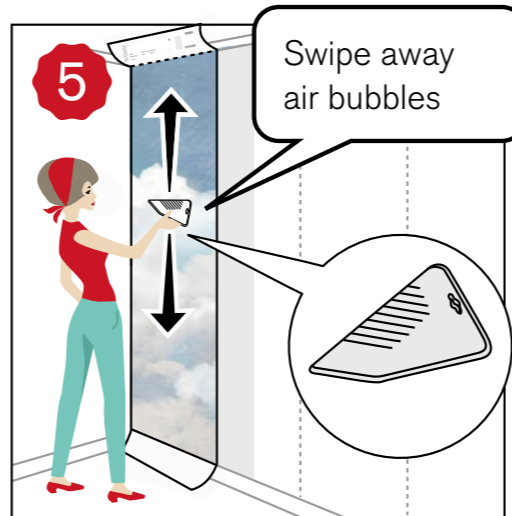
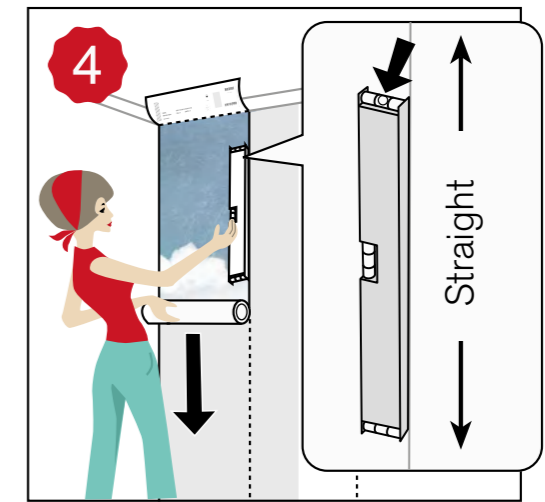



BEFORE YOU BEGIN

The surface of the wall must be smooth, clean, dry and sound. Flaking paint and loose wallpaper should be removed, and any uneven surfaces must be filled. Give the wall a prime coating if its colour is very different to the new wallpaper. Very absorbent surfaces, such as plaster walls, should be sized.

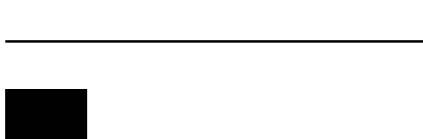

FÖRETAPETSERING

Väggen ska vara slät, ren, torr och väl förankrad. Gammal färg och tapet som inte sitter fast måste tas bort och spacklas över vid behov. Grundmåla om väggen har starka färgskiftningar. Förlimma om underlaget är starkt sugande, som exempelvis en gipsvägg.

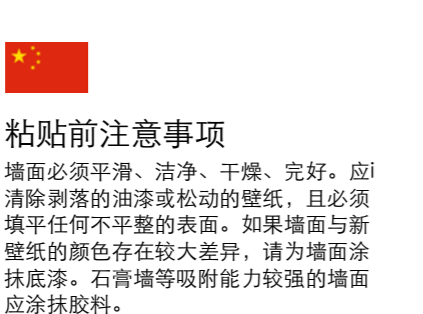
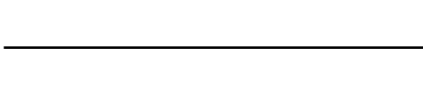

RECOMMENDED TOOLS

- Rollers and tray
- Bucket
- Pencil
- Craft knife
- Paintbrush (For the areas that the roller misses, e.g. along the ceiling and skirting boards)
- Ställinjal (För ev. stöd vid renskärnning vid golv och tak)
- Tapetsvamp (Mjuk trasa eller svamp; helst cellulossavamp)
- Blyertsenna
- Tapetkniv

RIGHT ADHESIVE

Always use an adhesive specially recommended for non-woven wallpaper.

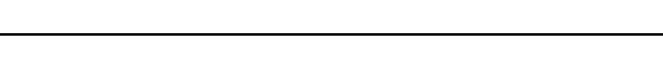

REKOMMENDERADE VERKTYG

- Roller & Tråg
- Hink
- Pensel (Där rollern inte kommer åt t.ex. vid tak och lister)
- Vattenpass eller lod (För att kontrollera att tapetväden hänger rakt)
- Tapetverktyg eller borste
- Ställinjal (För ev. stöd vid renskärnning vid golv och tak)
- Tapetsvamp (Mjuk trasa eller svamp; helst cellulossavamp)
- Blyertsenna
- Tapetkniv

RÄTT LIM

Använd alltid lim specifikt för non-woven tapeter.

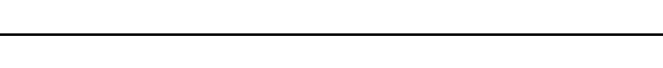

EMPFOHLENES WERKZEUG

- Roller und Schale
- Eimer
- Pinsel (für mit dem Roller nicht erreichbare Stellen, z. B. Leisten)
- Wasserwaage oder Lot (zur Kontrolle, ob die Tapetenbahn gerade hängt)
- Tapetierwerkzeug oder Bürste
- Stahllineal (eventuell als Stütze beim Feinschnitt an Decke und Fußboden)
- Tapetenschwamm (weicher Lappen oder Schwamm, möglichst ein Zellolosschwamm)
- Bleistift
- Tapetiermesser

DER RICHTIGE KLEISTER

Es ist immer spezieller Kleister für Vliestapeten zu verwenden.

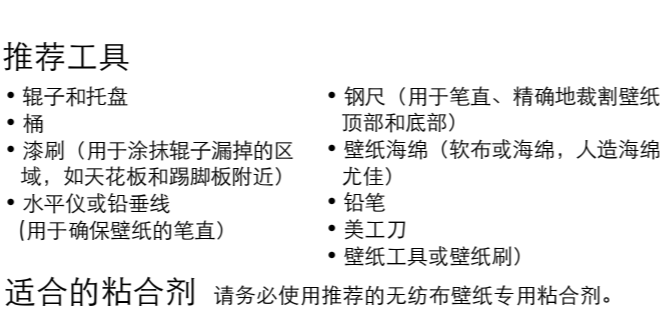
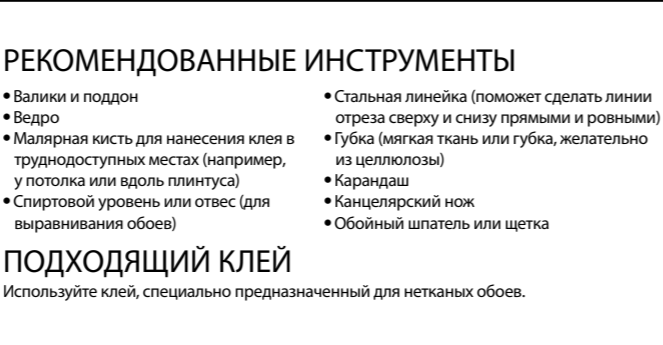
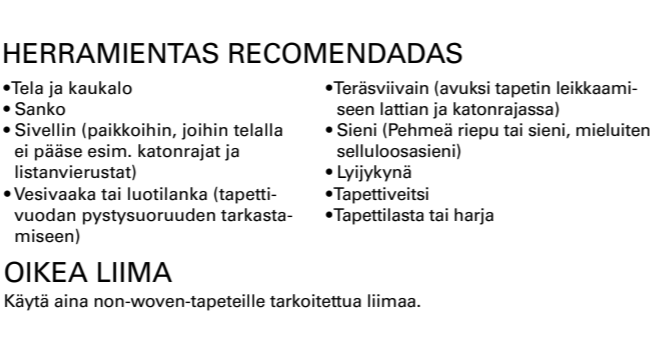
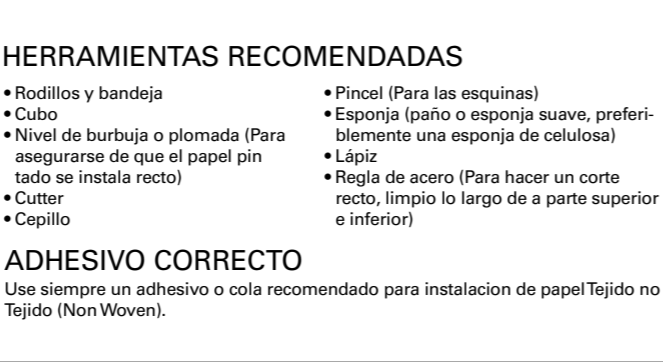
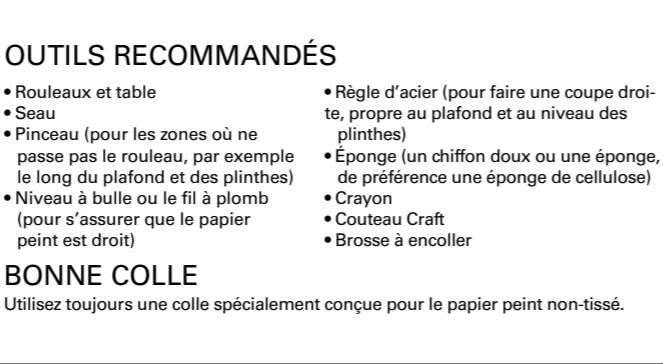

HANGING WALLPAPER 1 → 11

Start by dividing the lengths as indicated by the cutting symbols. Lay the lengths, with the label facing upwards, in numerical order starting with length number 1. Make sure you have all the lengths and that none of them are defective or damaged.

2-10. The lengths are numbered in the order in which they must be hung. The lengths should be hung edge to edge without any overlapping. It is essential that the first length is vertically straight. Tip: Make a pencil mark one wallpaper width along the wall near the ceiling. Hold a plumb line on the mark and draw

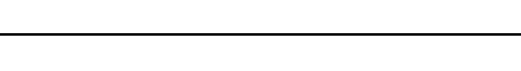

MONTERING AV TAPET 1 → 11

Börja med att dela isär väderna enligt skärmarkeringarna. Lagg sedan väderna med etiketten uppåt i nummerordning med våd nr.1 först. Kontrollera att alla våder är med och ingen våd är defekt eller skadad.

2-10. Alla våder är numererade i den följd de ska monteras. Väderna ska monteras kant i kant vilket innebär att de inte ska överlappas. Det är viktigt att första våden monteras rakt. Tips är att göra ett lodat blyertsstreck, en tapetvåd in på väggen och



ANBRINGUNG DER TAPETE 1 → 11

Zunächst die Bahnen den Schnittmarkierungen entsprechend abschneiden. Danach sind sie, beginnend mit Bahn Nr.1, in Nummernreihenfolge mit dem Etikett nach oben auszubreiten. Überprüfen Sie bitte, ob alle Bahnen vorhanden sind und keine beschädigt oder fehlerhaft ist.

2-10. Alle Bahnen sind in der Reihenfolge nummeriert, in der sie anzubringen sind. Sie sind auf Stoß anzubringen, dürfen sich also nicht überlappen. Es ist wichtig, dass die erste Bahn vertikal gerade angebracht wird. Hierfür empfiehlt sich, einen ausgete-ten senkrechten Strich mit dem Bleistift zu ziehen und die erste

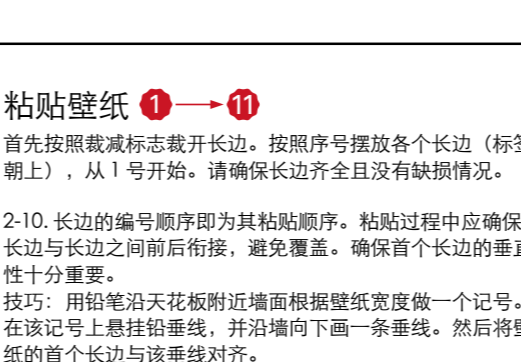
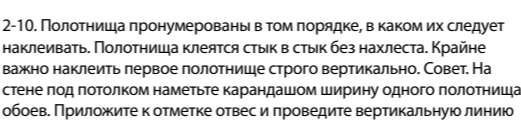
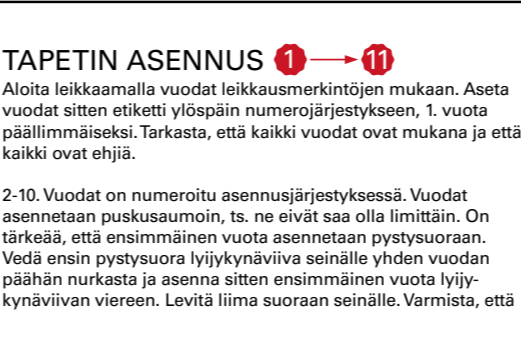
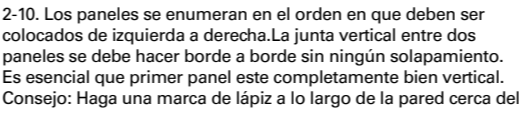
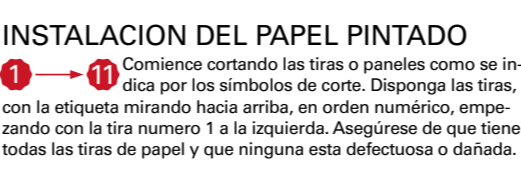
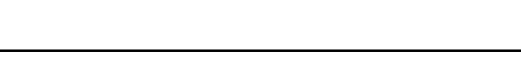
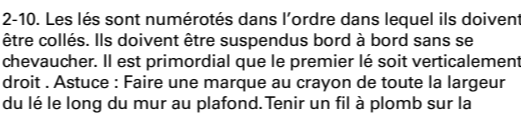
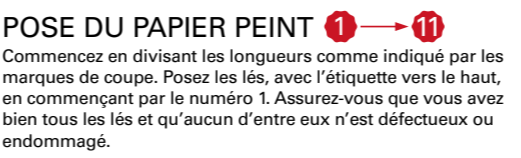
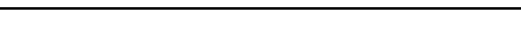
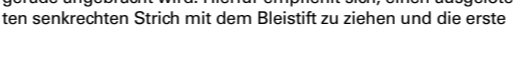

a vertical line down the wall. Then line up your first length of wallpaper with this pencil line.

Roll the paste straight onto the wall. Be sure to evenly cover the entire surface. If you miss a spot, this will cause the wallpaper to bubble. Paste an area the width of one and a half lengths at a time. Gently and evenly press the lengths together to ensure there are no visible seams. Make sure the wall has been pasted where the lengths meet so that the edges are not visible. Try not to get paste on the front of the wallpaper. Any excess paste should be removed immediately using a wet wallpaper sponge.

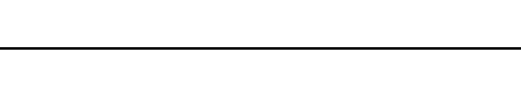

sedan montera första våden längst med blyertsstrecket.

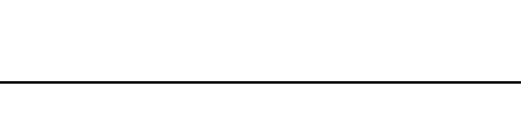
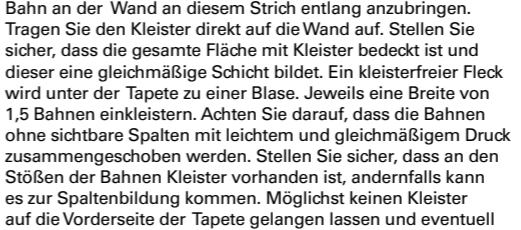
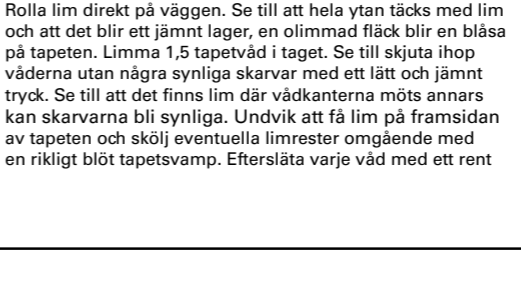

marque et tracez une ligne verticale le long du mur. Puis alignez le premier lé de papier peint sur cette ligne faite au crayon.

Appliquez la colle directement sur le mur. Assurez-vous de couvrir uniformément toute la surface. Si vous oubliez une surface quelconque, cela va engendrer des bulles sur le papier peint. Collez une zone de la largeur d'un lé et demi à la fois. Doucement et uniformément, appuyez sur les lées pour s'assurer qu'il n'y a pas de bords visibles. Assurez-vous que le mur a été collé ou les lées se rencontrent afin que le premier lé soit verticalement droit. Astuce : Faire une marque au crayon de toute la largeur du lé le long du mur au plafond. Tenir un fil à plomb sur la

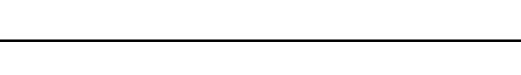

techo. Mantenga una plomada en la marca y dibujar una línea vertical en la pared a la distancia de la esquina del ancho de un panel.

Aplicar la cola con el rodillo directamente sobre la pared. Asegúrese de cubrir uniformemente toda la superficie. Si se olvidó de un punto, esto hará que aparezca una burbuja en el papel. Aplique cola en la pared cubriendo el ancho de un panel y medio. Ahora coloque la primera tira desde arriba y presiónelo suavemente y de manera uniforme siga aplicando cola en la pared e instale la segunda tira . Asegúrese de que los bordes laterales queden perfectamente enfrentados de manera que la junta del papel se vea lo menos posible. Trate de ensuciar de cola lo

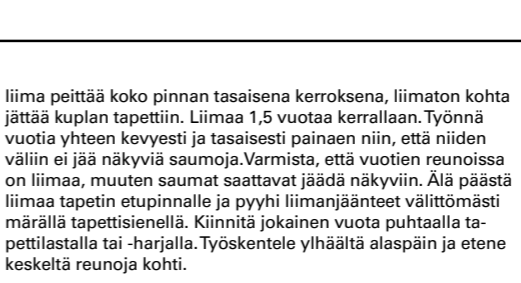

11. Kun koko tapetti on paikallaan, leikkaa ylimääräinen tapetti lattian ja katon rajasta. Käytä terävää tapetteiveistä, jotta

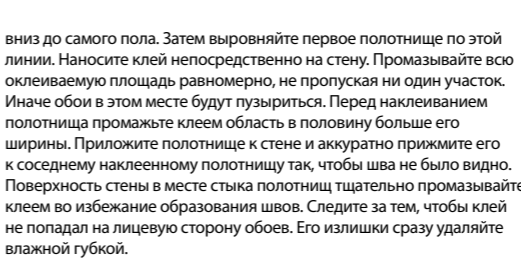
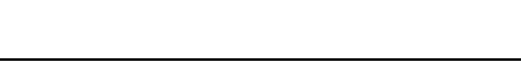

vinjs do самого пола. Затем выровняйте первое полотнище по этой линии. Нанесите клей непосредственно на стену. Промазывайте всю оклеиваемую площадь равномерно, не пропуская ни один участок. Иначе обои в этом месте будут пузырится. Перед наклеиванием полотнища промажьте клеем область в половину больше его ширины. Приложите полотнище к стене и аккуратно прижмите его к соседнему наклеенному полотнищу так, чтобы шва не было видно. Поверхность стены в месте стыка полотнищ тщательно промазывайте клеем во избежание образования швов. Следите за тем, чтобы клей не попал на лицевую сторону обоев. Его излишки сразу удаляйте влажной губкой.

在墙上直接涂抹一层糝糊。请确保糝糊涂层均匀覆盖整个墙面，如果漏掉某一处，将导致壁纸出现鼓包现象。一次粘贴一个宽边 和半个长边。轻柔均匀地将长边按压在一起，确保无明显接缝。确保壁纸长边与墙面吻合，不会露出墙面边缘。请勿使壁纸正面 沾染糝糊。应使用沾湿的壁纸海绵立即清除多余糝糊。

使用洁净的糝糊工具或壁纸刷压平各个长边。按压方向是从天花板到地面、从中间到两边。

11. 所有壁纸粘贴完成后，请沿天花板和地面裁掉所有多

Smooth each length with a clean wallpaping tool or wallpaper brush. Work from the ceiling to the floor and from the middle out to the edges.

11. Once the whole wallpaper has been hung, cut off any excess along the ceiling and floor. Always use a sharp blade to avoid tearing the paper. Keep the room ventilated and at normal room temperature for 24 hours to allow the paste to dry completely.

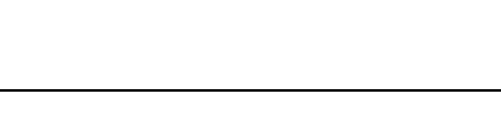

tapetverktyg eller tapetborste. Arbeta från tak mot golv och från mitten mot kanterna.

11. När hela tapeten är på plats skär bort överflödig tapet vid golv och tak. Ha alltid vassa blad för att inte trasa sönder tapeten. Vådra rummet 1 1 dygn men håll normal rumstemperatur så limmet torkar.

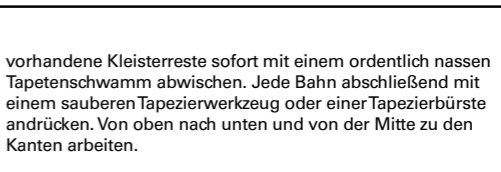

11. Sobald die ganze Tapete angebracht wurde, sind überschüssige Reste an Decke und Fußboden abzuschneiden. Die Klingen müssen immer richtig scharf sein, damit die Tapete nicht zerstört wird. Den Raum 24 Stunden bei normaler Zimmertemperatur lüften, damit der Kleister trocknen kann.

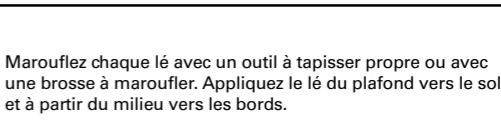

Marouffez chaque lé avec un outil à tapisser propre ou avec une brosse à maroufler. Appliquez le lé du plafond vers le sol et à partir du milieu vers les bords.

11. Une fois l'ensemble du papier peint tapissé, coupez tous les surplus le long du plafond et du plancher. Toujours utiliser une lame tranchante pour éviter de déchirer le papier. Gardez la pièce ventilée et à température ambiante pendant 24 heures pour permettre à la colle de sécher complètement.

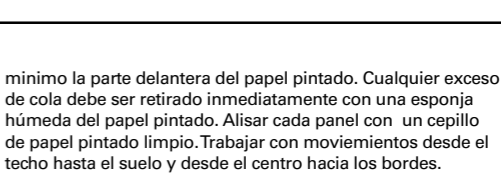

11. Una vez que todo el papel pintado se ha colocado, corte el material sobrante a lo largo del techo y el suelo. Siempre utilice una cuchilla afilada para evitar que se rompa el papel. Mantenga la habitación ventilada y en condiciones normales de temperatura ambiente durante 24 horas para permitir que la cola se seque por completo.

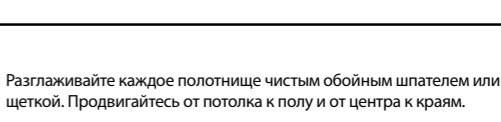
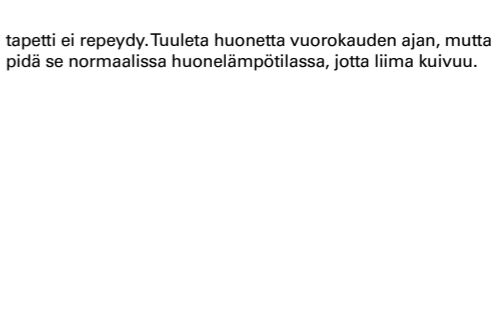
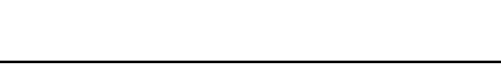

Разглаживайте каждое полотнище чистым обойным шпательем или щеткой. Продвигайтесь от потолка к полу и от центра к краям.

11. После наклеивания всех обоев отрежьте лишнюю длину вдоль пола и потолка. Чтобы бумага не порвалась, делайте это острым ножом. Наклеенные обои должны просохнуть в тенине 24 часов при комнатной температуре и достаточной вентиляции.

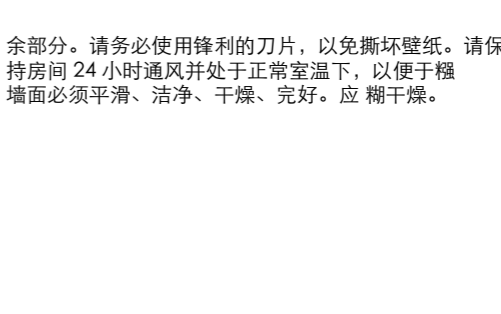

INSTRUCTIONS 95

REBEL WALLS | BEST OF



R13051 | BELLEWOOD **R**

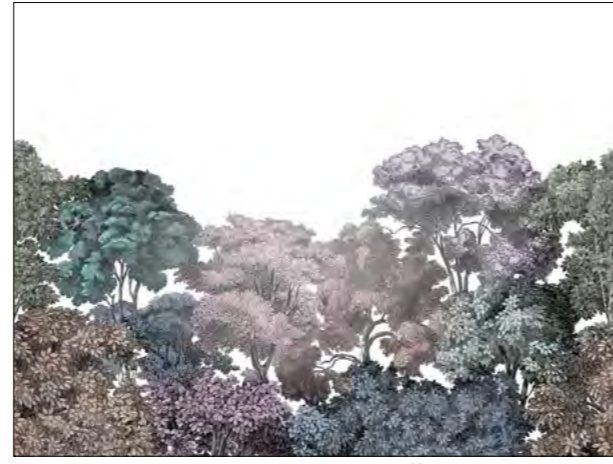

R13052 | BELLEWOOD, RAINBOW **R**

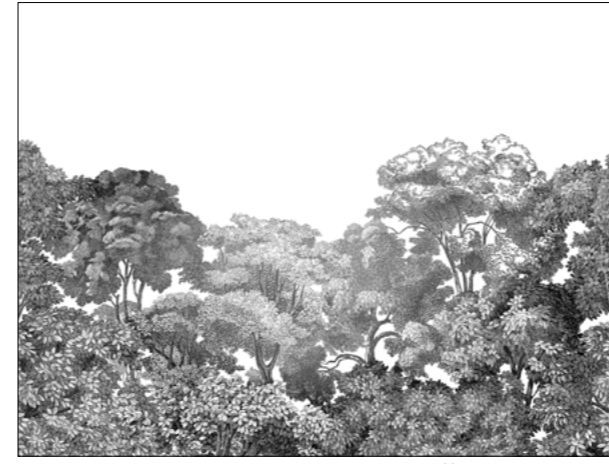

R13053 | BELLEWOOD, BLACKTOILE **R**



R13054 | BELLEWOOD, GREY TOILE **R**



R13057 | BELLEWOOD, PINK **R**



R14371 | PERSPECTIVE JARDIN **R**



R14591 | MISCHIEVOUS MONKEYS **R**



R14592 | MISCHIEVOUS MONKEYS, LUSH **R**



R14531 | MAY MEADOW **R**



R14532 | MAY MEADOW, PASTEL **R**



R13141 | MEADOW **R**



R13142 | MEADOW, COLOR **R**



R15391 | BLOOMING **R**



R14381 | FACTORY WINDOW **R**



R14001 | LEAF LOVE



R12711 | PATINA **R**



R14321 | INDUSTRIAL IVORY **R**



R14201 | PERSPECTIVE MANOIR **R**



R15001 | WOODEN CONCRETE **R**



R12671 | STEEL **R**

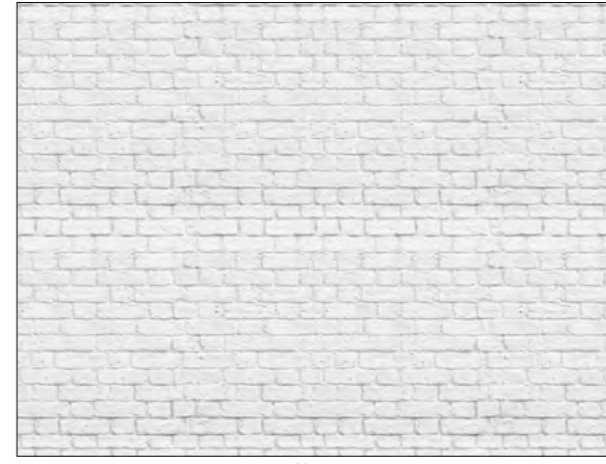

R14871 | SOFT BRICKS **R**

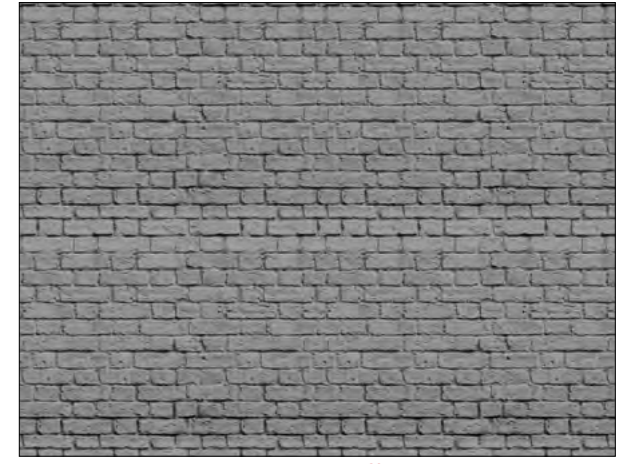

R14872 | SOFT BRICKS, GREY **R**

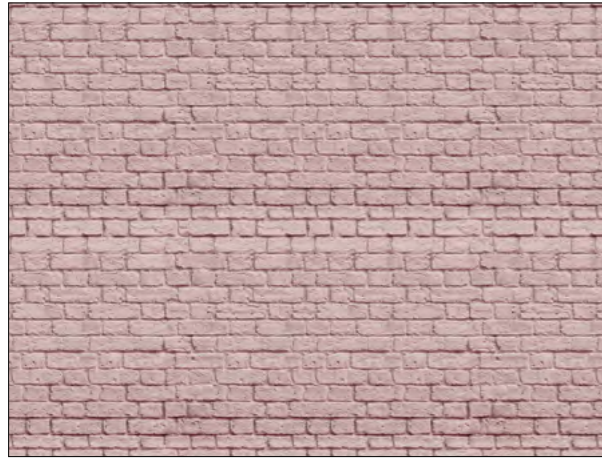

R14873 | SOFT BRICKS, PINK **R**



R12791 | BATTERED WALL **R**

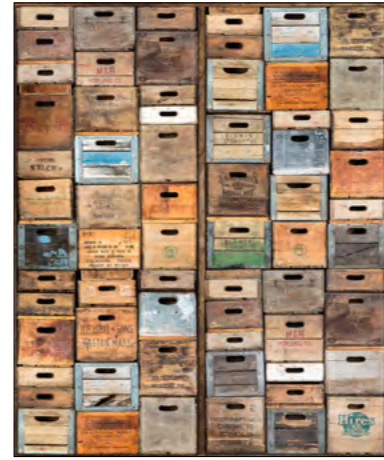

R12901 | INDUSTRIEL URBAN FARM L.A. **R**



R12902 | INDUSTRIEL URBAN FARM L.A. VINTAGE **R**



R14011 | CUDDLE CLOUDS **R**



R15301 | MORNING FOG **R**

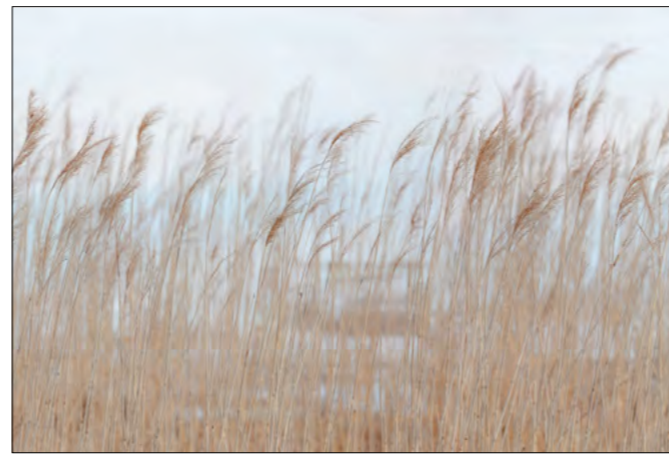

R13602 | SWAYING REED **R**



R13031 | BIRCH TRUNKS

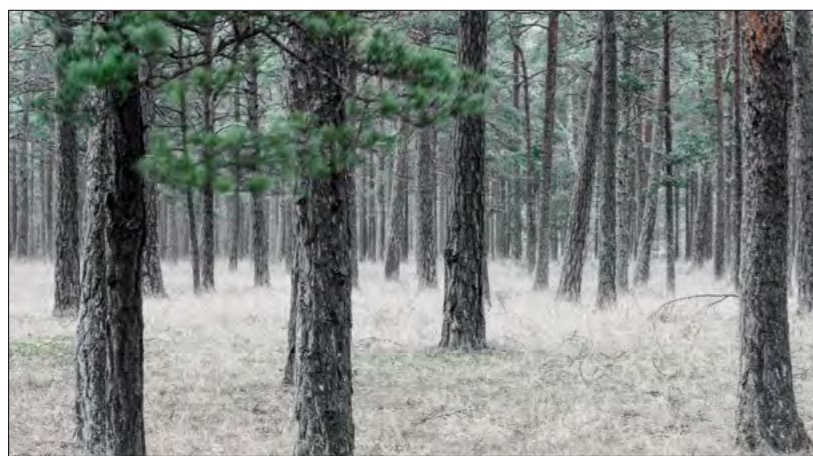

R13711 | PINE FOREST

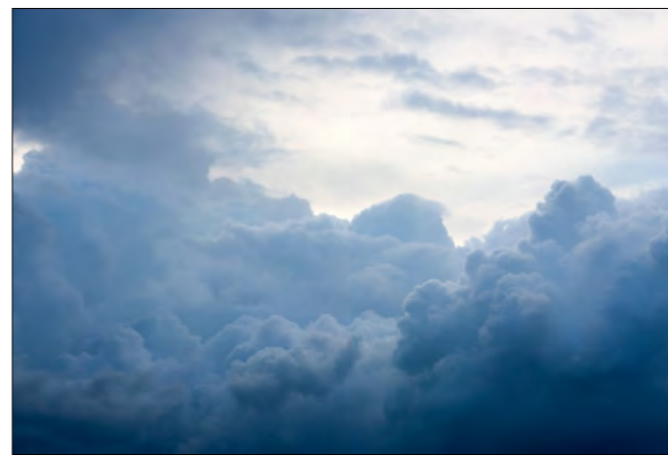

R13681 | ABOVE THE CLOUDS



R12971 | SCANDINAVIAN LIGHT



R13021 | OLD PINE TREES



R14481 | WOODS OF WONDER **R**



R14461 | THE ENCHANTED FOREST, DAYLIGHT **R**



R14462 | THE ENCHANTED FOREST **R**



R14551 | THE RABBIT'S PLAYGROUND R

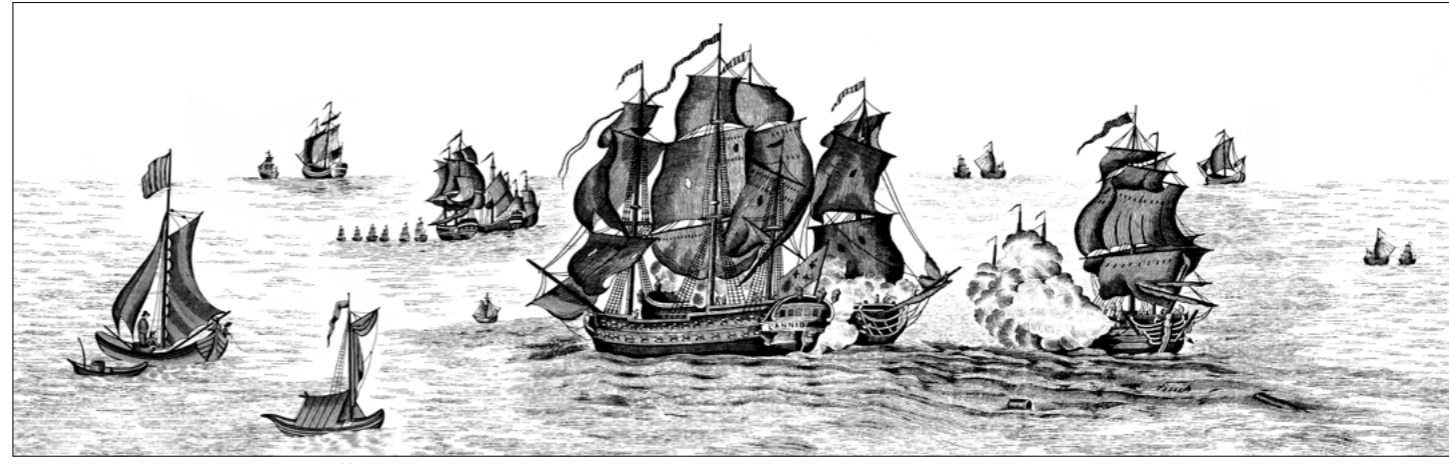

R14501 | HIGH SEAS, BLACK R



R14502 | HIGH SEAS R



R14503 | HIGH SEAS, HENDERSON BLUE R



R14611 | JUNGLE LAND, VINTAGE R

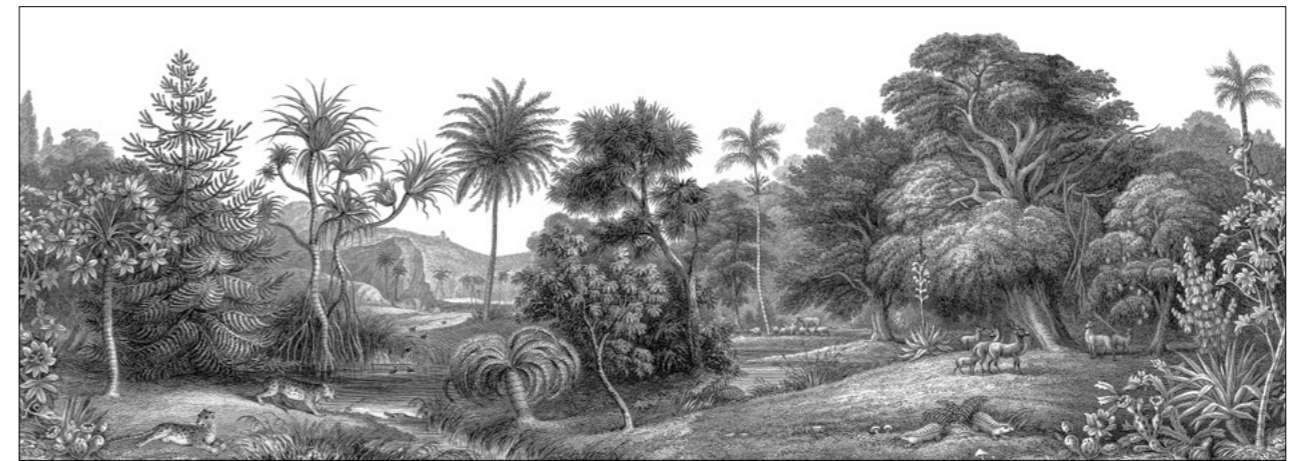

R14612 | JUNGLE LAND R



R14613 | JUNGLE LAND, VERDANT R

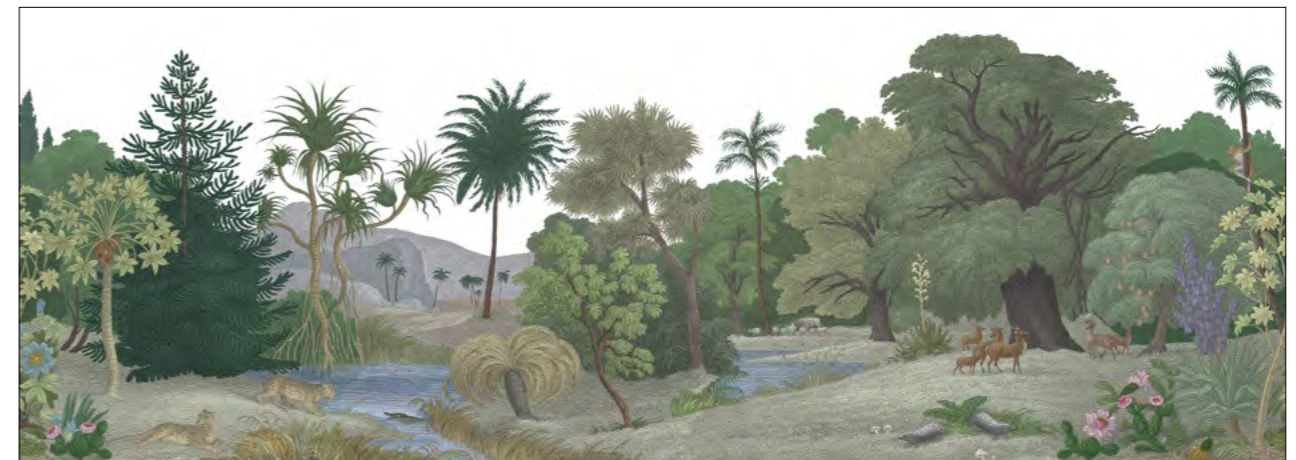

R14614 | JUNGLE LAND, COLOR R



R14601 | LONDON HOUSES R



R14091 | PULSE OF PASSION R

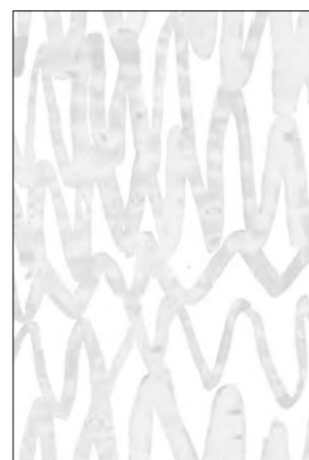

R14092 | PULSE OF PASSION, WHITE R



R14093 | PULSE OF PASSION, BLUE R



R14094 | PULSE OF PASSION, MINT R



R14095 | PULSE OF PASSION, PINK R

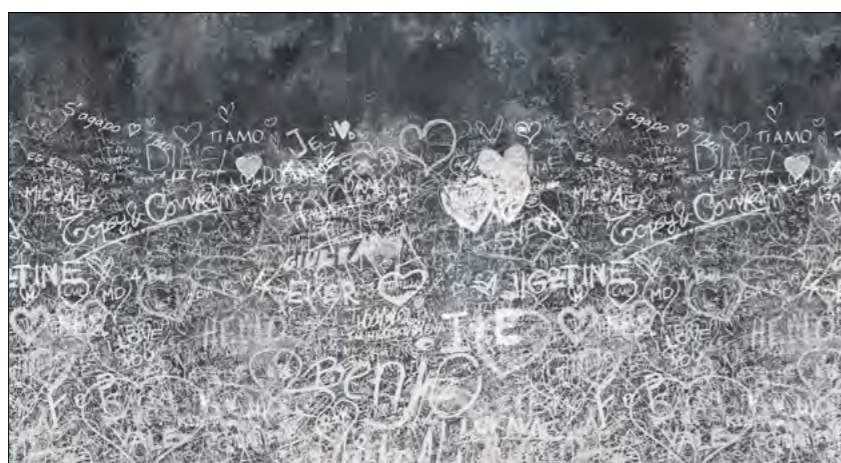

R13731 | VERONA **R**



R13901 | SCHOOL ATLAS



R13902 | SCHOOL ATLAS, RAINBOW

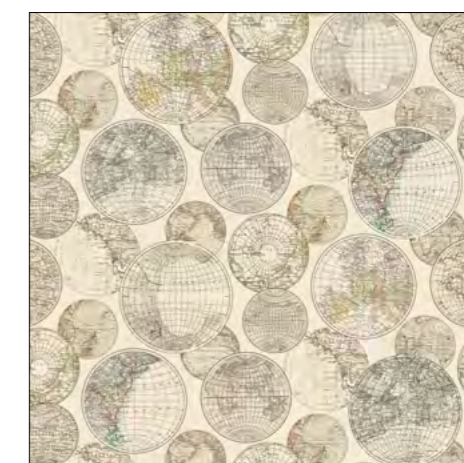

R13881 | GLOBES GATHERING **R**

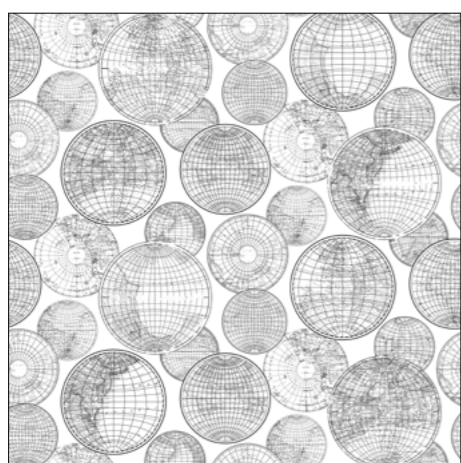

R13882 | GLOBES GATHERING, BLACK AND WHITE **R**

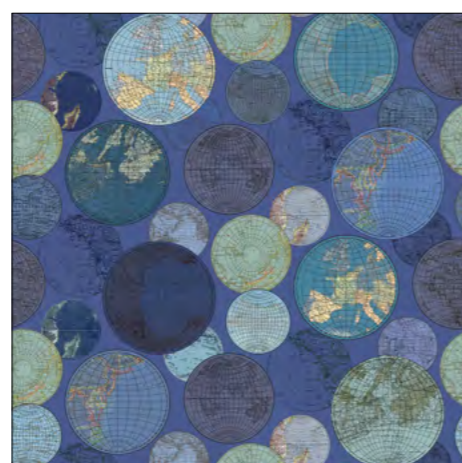

R13883 | GLOBES GATHERING, BLUE **R**



R13884 | GLOBES GATHERING, DEW **R**



R13871 | PAPER MOUNTAINS **R**



R15351 | AROUND THE WORLD **R**

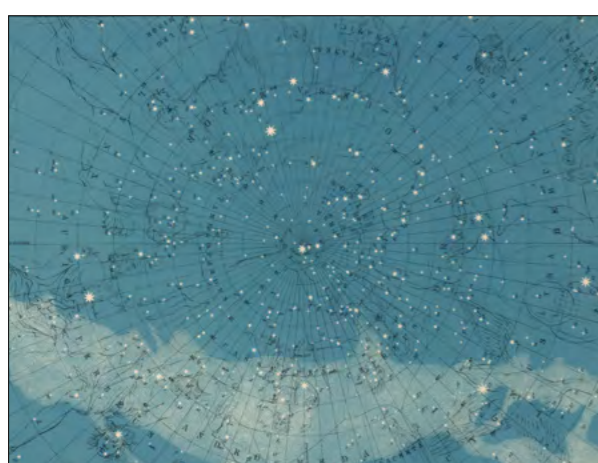

R13811 | ATLAS OF ASTRONOMY



R10771 | WORLD MAP



R10772 | WORLD MAP, BROWN



R10773 | WORLD MAP, BLUE



R13861 | TREASURE HUNT **R**

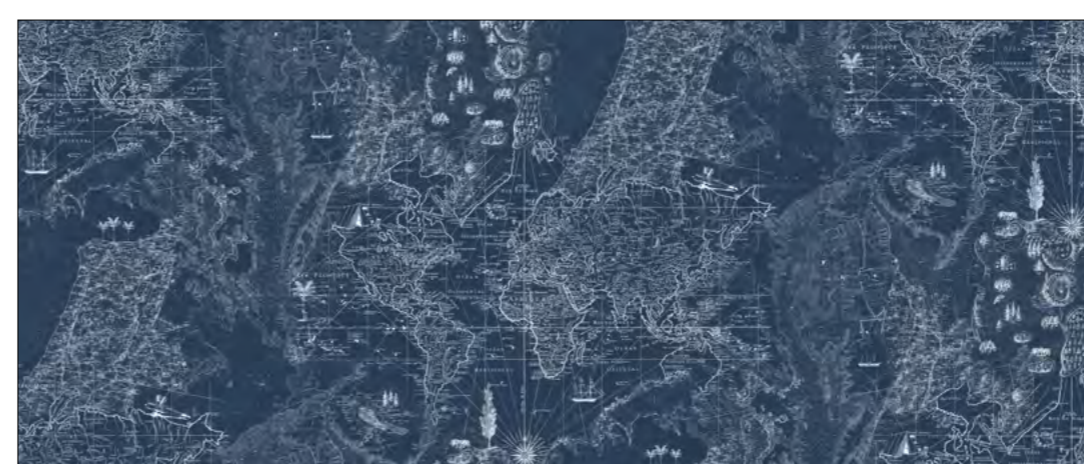

R13862 | TREASURE HUNT, MIDNIGHT **R**



R13863 | TREASURE HUNT, BLACK AND WHITE **R**



R13431 | RAINBOW WORLD

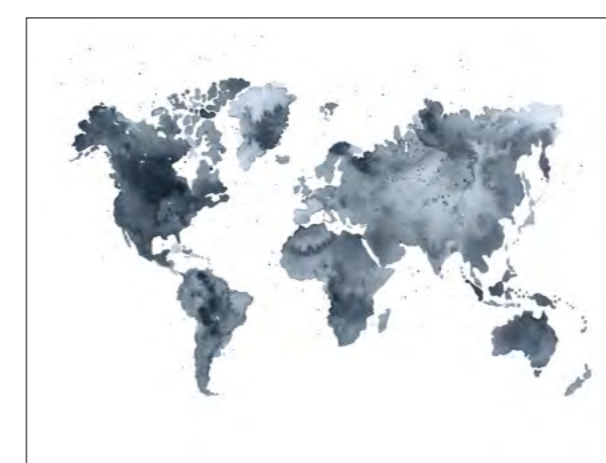

R13432 | DUSKY WORLD

HOW IT WORKS

- 1) Select your wallpaper from the collection book or on our website.
- 2) Measure the width and the height of your wall.
- 3) Add the width and height of your wall to your order. We produce the wallpaper with your measurements and deliver in a few days.

ARTICLE NO	NAME	PAGE	ARTICLE NO	NAME	PAGE
R10771	World Map	88-89	R14001	Leaf Love	20-21
R10772	World Map, Brown	88-89	R14011	Cuddle Clouds	44-45
R10773	World Map, Blue	88-89	R14091	Pulse of Passion	72-73
R12671	Steel	32-33	R14092	Pulse of Passion, White	72-73
R12711	Patina	24-25	R14093	Pulse of Passion, Blue	72-73
R12791	Battered Wall	36-37	R14094	Pulse of Passion, Mint	72-73
R12901	Industriel Urban Farm L.A.	38-39	R14095	Pulse of Passion, Pink	72-73
R12902	Industriel Urban Farm L.A., Vintage	38-39	R14201	Perspective Manoir	28-29
R12971	Scandinavian Light	54-55	R14321	Industrial Ivory	26-27
R13021	Old Pine Trees	56-57	R14371	Perspective Jardin	8-9
R13031	Birch Trunks	48-49	R14381	Factory Window	18-19
R13051	Bellewood	6-7	R14461	The Enchanted Forest, Daylight	62-63
R13052	Bellewood, Rainbow	6-7	R14462	The Enchanted Forest	62-63
R13053	Bellewood, Black Toile	6-7	R14481	Woods of Wonder	60-61
R13054	Bellewood, Grey Toile	6-7	R14501	High Seas, Black	66-67
R13057	Bellewood, Pink	6-7	R14502	High Seas	66-67
R13141	Meadow	14-15	R14503	High Seas, Henderson Blue	66-67
R13142	Meadow, Color	14-15	R14531	May Meadow	12-13
R13431	Rainbow World	92-93	R14532	May Meadow, Pastel	12-13
R13432	Dusky World	92-93	R14551	The Rabbit's Playground	64-65
R13602	Swaying Reed	46-47	R14591	Mischievous Monkeys	10-11
R13681	Above The Clouds	52-53	R14592	Mischievous Monkeys, Lush	10-11
R13711	Pine Forest	50-51	R14601	London Houses	70-71
R13731	Verona	74-75	R14611	Jungle Land, Vintage	68-69
R13811	Atlas Of Astronomy	86-87	R14612	Jungle Land	68-69
R13861	Treasure Hunt	90-91	R14613	Jungle Land, Verdant	68-69
R13862	Treasure Hunt, Midnight	90-91	R14614	Jungle Land, Color	68-69
R13863	Treasure Hunt, Black and White	90-91	R14871	Soft Bricks	34-35
R13871	Paper Mountains	82-83	R14872	Soft Bricks, Grey	34-35
R13881	Globes Gathering	80-81	R14873	Soft Bricks, Pink	34-35
R13882	Globes Gathering, Black and white	80-81	R15001	Wooden Concrete	30-31
R13883	Globes Gathering, Blue	80-81	R15301	Morning Fog	42-43
R13884	Globes Gathering, Dew	80-81	R15351	Around the World	84-85
R13901	School Atlas	78-79	R15391	Blooming	16-17
R13902	School Atlas, Rainbow	78-79			

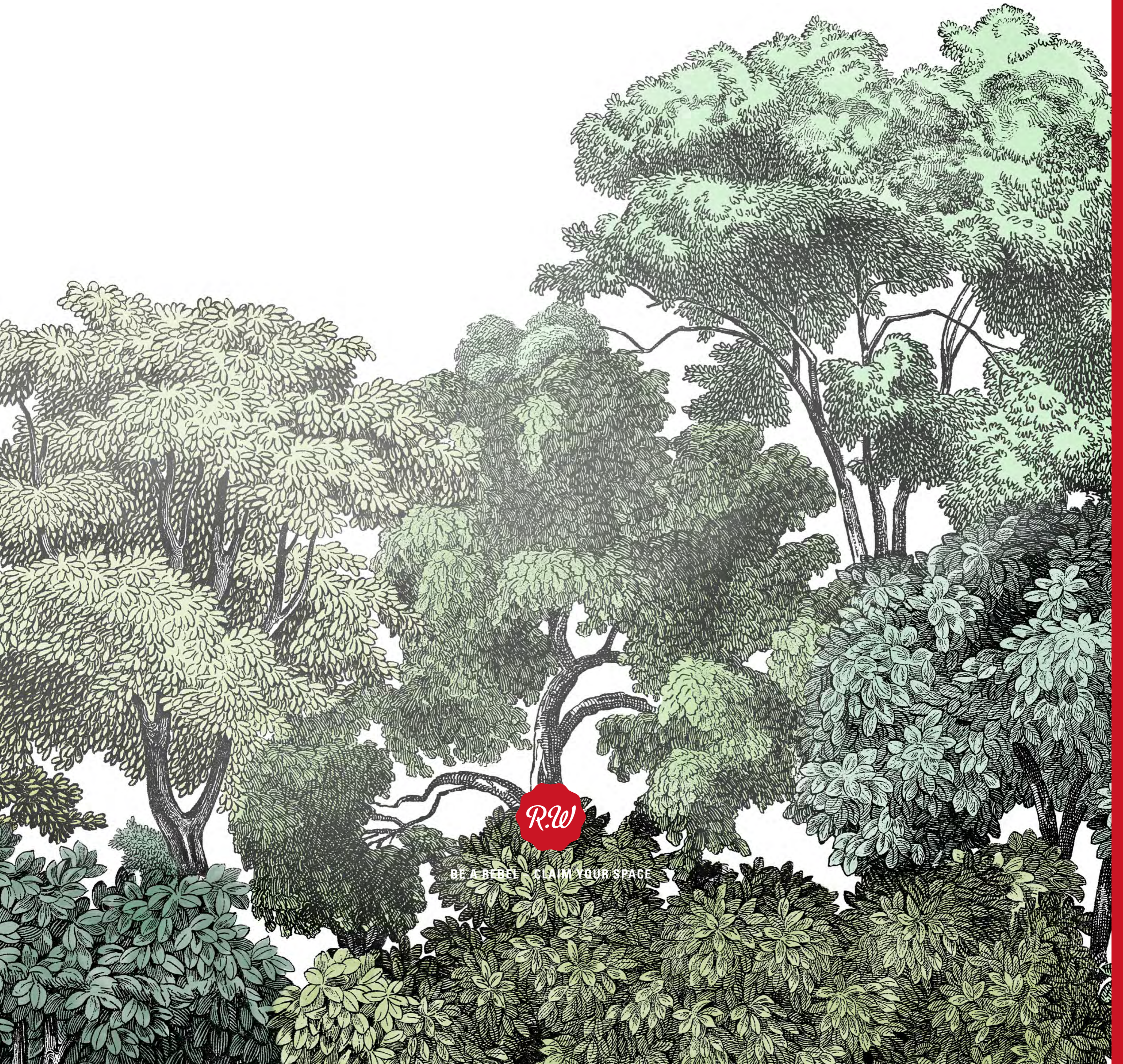

BE A REBEL. CLAIM YOUR SPACE.

